

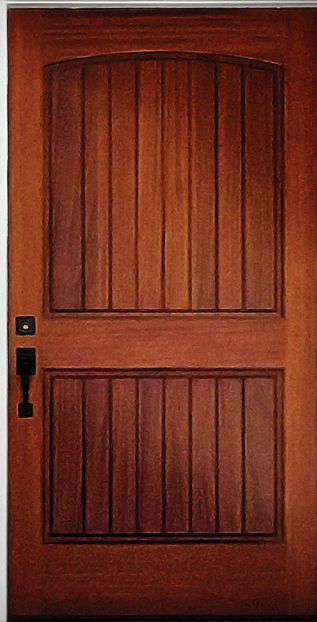

CAPTIVA
wood doors





CAPTIVA

wood doors

ALLOW YOURSELF TO BE CAPTIVATED. DISCOVER DOORS THAT ARE DIFFERENT FROM THE INSIDE OUT. BEAUTIFUL WOOD DOORS THAT ARE MADE WITH ONLY THE FINEST HAND-SELECTED MATERIALS AND ARE CONSTRUCTED USING A BALANCE OF OLD WORLD CRAFTSMANSHIP COMBINED WITH STATE-OF-THE-ART TECHNOLOGY. EVERY CAPTIVA DOOR IS CUSTOM MADE TO EXACT SPECIFICATIONS TO BE PERFECT EVERY TIME, A DOOR THAT WILL BE CHERISHED AND ADMIRER FOR YEARS TO COME.



We keep moving forward, opening new doors,
and doing new things, because we're curious
and curiosity keeps leading us down new paths.

- Walt Disney



CAPTIVA
wood doors

Handcrafted in New England, which is synonymous with “Old World” traditions and fine, detail-oriented architecture, Captiva Wood Doors are built to your specifications. Creating a fusion of traditional woodworking techniques and technology, Captiva Wood Doors offer thousands of possibilities.

Artistic consciousness with the look and feel of quality is easy to recognize on our doors. We offer stave core construction, premium thickness veneers, traditional stile and rail construction, and superior panel design, as well as a choice between mortise and tenon and our very own “beaded” tenon. All pieces are hand fit together with the industry's finest adhesives on all connections.

Backed by our extensive warranty, these doors are both beautiful and exceptionally built with the next generation of owner in mind.

Table of contents.

Made in U.S.A.	4
Steps to Designing Your Door	6
Anatomy of a Door	7
Door Shapes and Thicknesses	8-9
Door Construction	10-11
Wood Species	12
Quick Ship Program	13
Panel and Sticking Options	14-15
Panel Doors	16-21
Louver Doors	21
Glass Door Options	22-23
Specialty Glass	24
Glass Doors	25-30
Modern Collection	32-35
Grooved and Beaded Doors	36-37
Double Door Arched Pairs	38-39
Barn Doors and Hardware	40-42
Dutch Doors	43
Sidelites and Transoms	44-45
Fire Doors	46-47
Screen and Storm Doors	48-50
Custom Designs	52
Door Comparison Chart	53
Jams, Casings and Sills	54-55
Hardware	56-60
Commercial Capabilities	61
Prefinishing	62-63
Warranty	64-65
Use and Care Guide	66
Architectural Specs	67

On the cover: 8009V with 8706V Sidelites, Sapele Mahogany

Inside front cover: Custom Designed Double Door Unit
and Custom Transom, Sapele Mahogany

WWW.CAPTIVAWOODDOORS.COM

Made in U.S.A.



CAPTIVA
wood doors

ALL CAPTIVA WOOD DOORS ARE ENGINEERED AND HANDCRAFTED TO ORDER AT OUR MANUFACTURING FACILITY IN SOMERSET, MA. WHEN YOU CHOOSE A CAPTIVA WOOD DOOR, NOT ONLY ARE YOU GUARANTEED A HANDMADE DOOR THAT WILL ADD BEAUTY TO YOUR HOME FOR YEARS TO COME, YOU ARE ALSO HELPING TO EMPLOY LOCAL CRAFTSMEN AND ARTISANS.



“ If opportunity doesn't knock, build a door. - Milton Berle ”



Designing your custom door.

EVERY CAPTIVA WOOD DOOR STARTS EXACTLY THE SAME: WITH THE HIGHEST QUALITY MATERIAL AND CONSTRUCTION. WHAT MAKES A DOOR UNIQUE ARE THE CHOICES YOU MAKE. EACH DOOR IS CUSTOM BUILT TO EXACT SPECIFICATIONS. WE OFFER INTERIOR AND EXTERIOR PANEL DOORS, GLASS DOORS, BARN AND SLIDING DOORS, DUTCH DOORS, SCREEN AND STORM DOORS.

CONFIGURATION	CONSTRUCTION	SPECIES
1 <ul style="list-style-type: none">· Door Shape· Sidelites· Transom	2 <ul style="list-style-type: none">· Joinery· Veneer· Door Thickness	3 <ul style="list-style-type: none">· Wood Species
PANEL AND STICKING	GLASS	FRAME SYSTEM
4 <ul style="list-style-type: none">· Standard Profile· Custom Profile	5 <ul style="list-style-type: none">· Clear· Decorative· Pane Thickness· Muntin Bars	6 <ul style="list-style-type: none">· Jamb· Sill· Casing· Trim
HARDWARE	FINISHING	WARRANTY
7 <ul style="list-style-type: none">· Residential· Multipoint· Electronic· Commercial	8 <ul style="list-style-type: none">· Clear Coat· Primed· Stain· Paint	9 <ul style="list-style-type: none">· Standard· Extended



Not sure where to begin? Scan the QR code to visit our online photo gallery and get inspired.





Anatomy of a door.

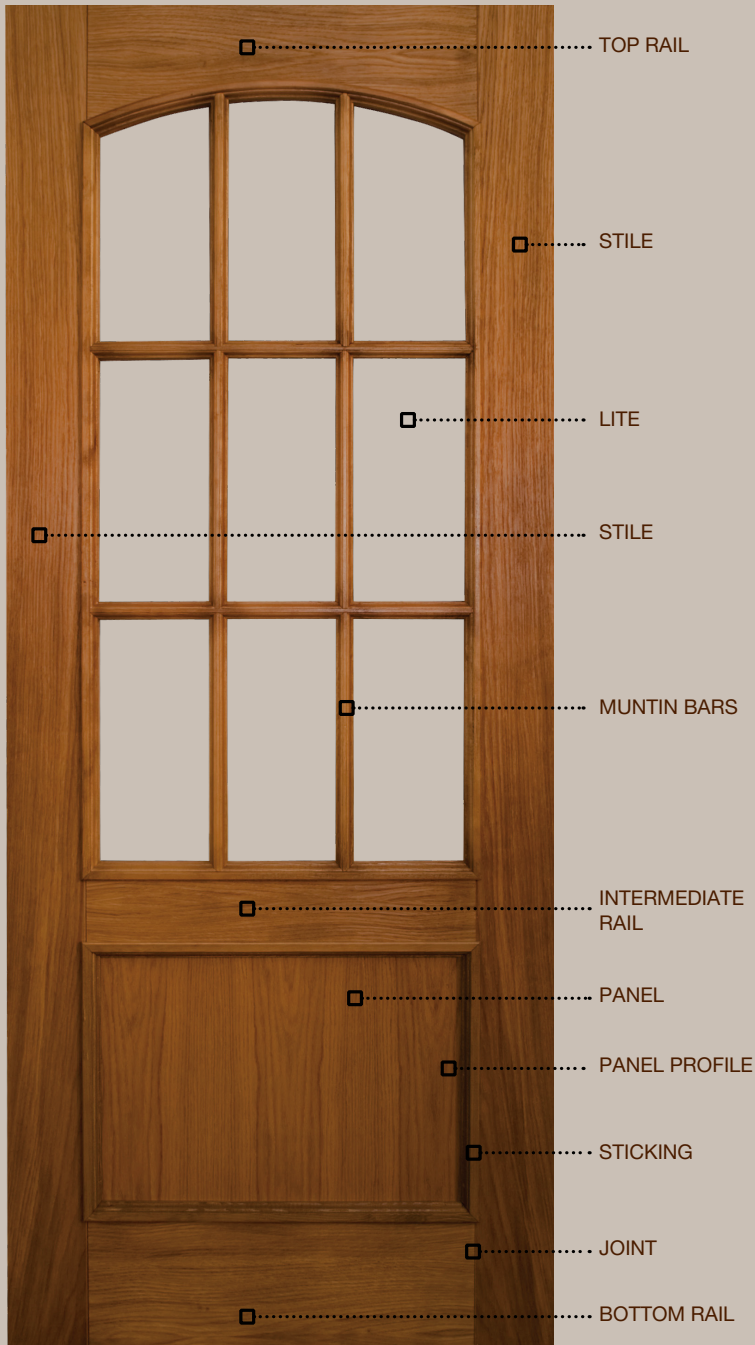

Glossary of terms.

Joinery

The method used to join the door stiles to the top, bottom, and lock rails. Examples include mortise & tenon, dowels, beaded mortise & tenon, lag screws or bolts. *See page 10 for more information.*

Lites

A framed opening in a door containing a pane of glass. *See pages 22-24 for glass options.*

Muntin Bars

The narrow horizontal and/or vertical bars in a door lite that separate the individual panes of glass. *See page 23 for muntin bar options.*

Panel Profile

The dimensional shape exposed edge of the outside perimeter of the panel. *See page 14 for panel profile options.*

Panels

The solid sections for the doors that are framed by the stiles and rails. *See page 14 for panel options.*

Rails

The horizontal components located at the top, bottom, and mid-sections of the door that extend between the stiles and frame the panels and lites.

Sticking

The profile that is moulded into the stiles and rails to frame and encase the panels or lites. *See page 15 for sticking options.*

Stiles

The vertical components located at the left and right edges of the door.

Door shapes.

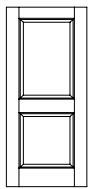

S
Square

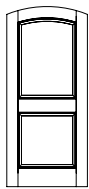

A
Arch

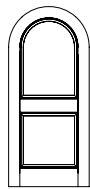

R
Round

TAKING INTO CONSIDERATION THE ARCHITECTURAL STYLE OF YOUR HOME OR THE LOOK THAT YOU WANT TO ACHIEVE, CAPTIVA WOOD DOORS ARE AVAILABLE IN OUR STANDARD SHAPES OF SQUARE, ARCHED OR ROUND. WE ALSO MAKE CUSTOM DOOR TOP SHAPES WHICH ARE OFTEN USED IN CHURCHES, REPRODUCTION PROJECTS, COMMERCIAL APPLICATIONS OR HOMES THAT REQUIRE A TRULY UNIQUE LOOK.



Custom Designed Double Door Units



8633A Door, Sapele Mahogany



Clipped Corner Doors

To maximize architectural integrity, Captiva Wood Doors are also available with clipped corners for doors that meet an angled ceiling (such as in an attic or under a stair).

Thickness/interior & exterior.

THERE ARE NO SUBSTITUTES FOR WOOD DOORS. THE STURDY MATERIALS USED ARE EXPENSIVE INITIALLY, BUT THEY PAY FOR THEMSELVES IN BUILDING CHARACTER AND DURABILITY IN THE LONG RUN. NATURAL BUILDING MATERIALS LIKE WOOD HAVE AN ORGANIC BEAUTY THAT CANNOT BE REPRODUCED BY SYNTHETIC SUBSTITUTES.



Modified 8347 Double Door Unit with Special Order Wrought Iron Grill, Sapele Mahogany



Modified 8009 Interior Door, Sapele Mahogany

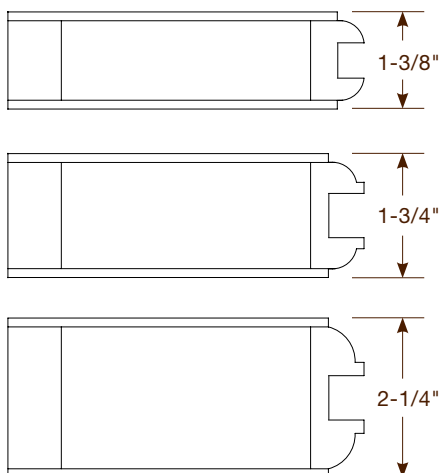

Interior and Exterior Doors

To help you coordinate all of the doors in your home, Captiva doors are made for both interior and exterior use. Builders, architects, and designers often consider the interior and exterior doors as two different design elements. Captiva allows both the interior and exterior doors to be supplied by one manufacturer with matching details in panels, sticking, and specie. As pictured above, matching the species of wood for all your doors, even if the individual designs of the door are not the same, will give you a unified look throughout the home while maintaining visual interest.

Door Thickness

We offer three standard door thicknesses: 1-3/8", 1-3/4", and 2-1/4". Our 1-3/8" doors are recommended and warranted for interior use only.

Door construction.



WE ARE PROUD TO OFFER TWO SERIES OF CAPTIVA WOOD DOORS. OUR CAPTIVA SELECT DOORS OFFER YOU ALL THE WELL-CRAFTED BEAUTY OF THE FINEST WOOD DOOR WITH A TWO YEAR WARRANTY. OUR CAPTIVA TRADITIONAL DOORS ARE CONSTRUCTED THE WAY CRAFTSMEN HAVE BEEN MAKING DOORS FOR CENTURIES, USING TRADITIONAL MORTISE AND TENON JOINERY. CAPTIVA TRADITIONAL DOORS ARE BACKED BY A FIVE YEAR WARRANTY, WITH A TEN YEAR EXTENDED WARRANTY AVAILABLE. ALL INTERIOR DOORS CARRY A TEN YEAR WARRANTY.

Captiva Select Doors

Constructed to the highest specifications, these doors use state-of-the-art beaded mortise and tenon joinery combined with stave core stiles and solid rails to ensure that every door is straight and true for years.

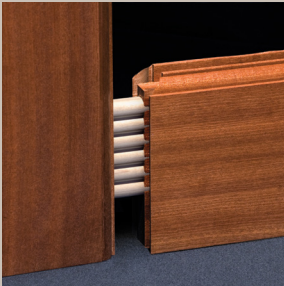

Beaded Mortise and Tenon
Tight fitting beaded mortise and tenon joinery is far superior to the doweled joints that most other door manufacturers use. Our beaded mortise and tenon provides more surface area for glue adhesion vastly increasing the strength of the joint.



Solid Rails
Optional stave core rails available



Stave Core Stiles with 1/8" Veneers

2 Year Warranty, (10 Year for Interior Doors)
(See pages 64-65 for warranty details)

Captiva Select doors meet AWI Premium standards and specifications when book match panels are specified.

Captiva Traditional Doors

With traditional mortise and tenon joinery, stave core stiles and rails, and 1/4" veneers, and these doors are made for the purest who appreciates a door that is made using classic door making methods.



Traditional Mortise and Tenon
Simple and strong, the mortise and tenon joint has been used for millennia by woodworkers around the world to join two pieces of wood. We've kept up the tradition by using this time tested method of joinery in our Captiva Traditional series doors.



Stave Core Rails with 1/4" Veneers



Stave Core Stiles with 1/4" Veneers



Solid Cap on Top Stiles Hides the Stave Core

5 Year Warranty, (10 Year for Interior Doors); 10 Year Extended Warranty available *(See pages 64-65 for warranty details)*

Captiva Traditional doors meet AWI Premium standards and specifications when book match panels are specified.

Standard Stile and Rail Dimensions

To the right please find the standard stile and rail dimensions that we use when constructing our Captiva Select and Traditional doors. If your project requires specific dimensions, we will be happy to modify these dimensions for our Captiva Traditional series doors.

Note: Dimensions include sticking.

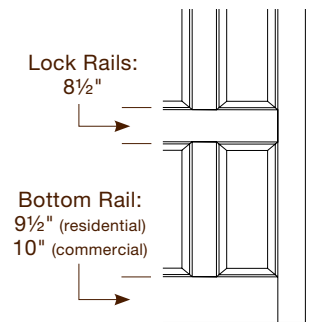
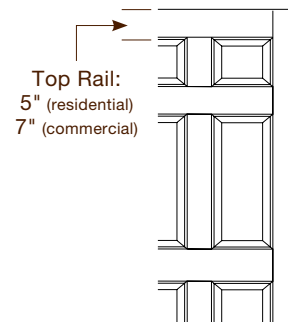
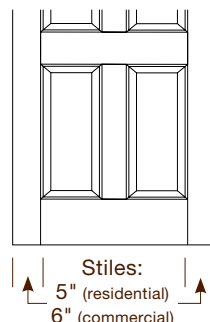



8030 Double Doors with 8751 Transom, Mahogany

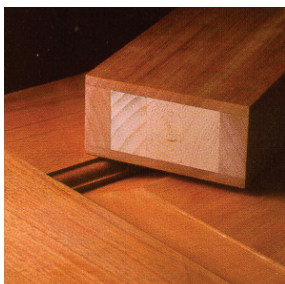

Stave Core Construction

This environmentally friendly method of construction uses laminated, stable, wood core sandwiched between solid veneers and matching edges for a stile and rail that are superior for preventing warping or distortion. Traditional Series doors have a solid wood top rail cap on stiles for a finished look. (Not available on Select Series).



Details Matter. A solid cap hides the core on top stiles; standard on Traditional Series doors only.

Wood species.



EVERY CAPTIVA DOOR BEGINS WITH PREMIUM SELECT GRADE LUMBER. WE METICULOUSLY GATHER WOOD FROM AROUND THE GLOBE TO ENSURE THAT EVERY DOOR THAT WE MAKE IS OF THE HIGHEST QUALITY. WE STRIVE TO PURCHASE WOOD PRODUCTS MADE FROM LUMBER HARVESTED IN A SUSTAINABLE MANNER AND CERTIFIED BY A RELIABLE THIRD PARTY SUCH AS FSC OR SFI. THE BOARDS AND VENEERS THAT GO INTO CONSTRUCTING EACH DOOR ARE HAND SELECTED SO THAT GRAIN AND COLOR ARE CONSISTENT.

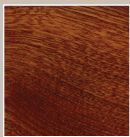

Sapele Mahogany (or Utile)*

Harvested in Africa, Sapele is very similar to Honduras Mahogany with a regular striped pattern and a dark red-brown color. This species sands and finishes easily and smoothly. *Interior and Exterior use.*

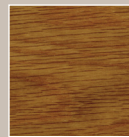

White Oak

White Oak is primarily warm in color with a hint of ash. It's grain pattern varies from straight and tight to arched and dramatic. White Oak stains well for an excellent finish. *Interior and Exterior use.*



Spanish Cedar

This hardwood varies from light to dark reddish brown. The texture is rather fine and uniform to coarse and uneven. Spanish Cedar is considered naturally decay resistant. *Interior and Exterior use.*

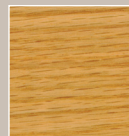

Red Oak

The texture of Red Oak features a very strong grain pattern which ranges from fine, straight, and close to spread and pronounced. Red Oak stains well for an excellent finish. *Interior use only.*



Fir

This is a dimensionally stable wood with a straight grain, uniform in color, pattern and texture. Its light warm hue will become more red with age. Fir stains easily and smoothly. *Interior and Exterior use.*

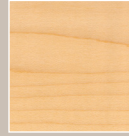

Maple

Maple is strong and hard with a uniform color, texture, and grain. It sometimes features areas with dark streaks and birds-eye or worm track patterns. If left clear, maple may yellow with age. *Interior use only.*



Eastern White Pine

This softwood is light brown in color, often with a reddish tinge and turns darker on exposure to air. Eastern White Pine features a comparatively uniform texture and is straight grained. *Interior and Exterior use.*

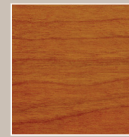

Cherry

Cherry is characterized by its warm color, smooth texture and straight, fine, and tight grain. Cherry may contain some sapwood and/or pin knots and will darken over time. *Interior use only.*

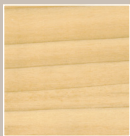

Poplar

This hardwood is light in color and may feature dramatic dark color variations. Poplar is mostly painted or used with dark stains. *Interior use only.*

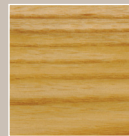

Ash

Ash ranges in color from brown to nearly white and may display a dramatic grain pattern. It is popular in woodworking because it is heavy, strong, hard, and stiff. *Interior use only.*



Knotty Alder

This softwood is characterized by its warm yellow to reddish brown color, even texture, straight grain and tight knots throughout. *Interior use only.*

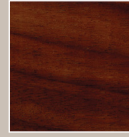

Walnut

Walnut is characterized by its beautiful grain lines running throughout and its dark brown color. Walnut veneers may be laminated for width and contain some sap grain and pin knots. *Interior use only.*

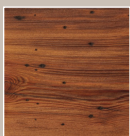

Reclaimed Wood

Reclaimed wood is seasoned lumber that has been salvaged from abandoned barns, factories and industrial buildings. Some common types are: pine, elm, cherry, chestnut, walnut, hickory, maple, and quartersawn oak.

*Sapele and Utile (also known as Sipo) are closely related to Genuine Mahogany and widely used in window and door manufacturing.

Special Specie Requests

When your project requires a specific specie not listed above, let us call on our lumber suppliers from all over the globe to find it.

Over 100 styles to choose from available in 3 weeks or less...



Quick Ship Doors



Look for the Quick Ship logo when choosing your Captiva Wood Doors. When these door styles are ordered in our Captiva Select Series and combined with the options listed below, they are available in three weeks or less.

Species:



Sapele
Mahogany

Fir

White Oak

Poplar
Interior only

Panel Options:

All panels options shown on page 14 are available on quick ship doors.

Sticking Options:

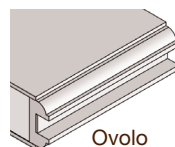

Ovolo

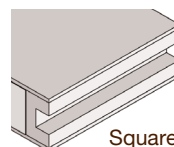

Square

Glass Options:

Clear Single Strength
Clear Insulated
Low-E

Muntin Bars:

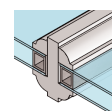

Ovolo
1-3/8"
TDL

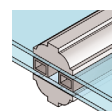

Ovolo
1-3/8"
SDL

Door Heights:

6'8", 7'0", 8'0"

Door Widths:

2'0" thru 3'6" (2" increments)

Door Thickness:

1-3/4"

Note: Three week lead time available in limited quantities.

Panel options.

Captiva offers a large selection of panel profile options for all of our wood doors. Each door style is available in the panel options shown.

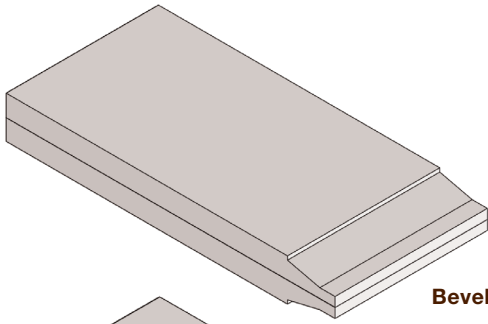

Bevel Panel

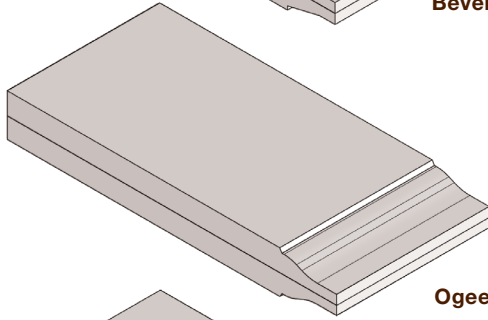

Ogee Panel

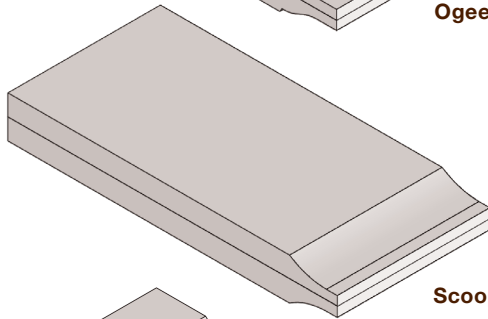

Scoop Panel

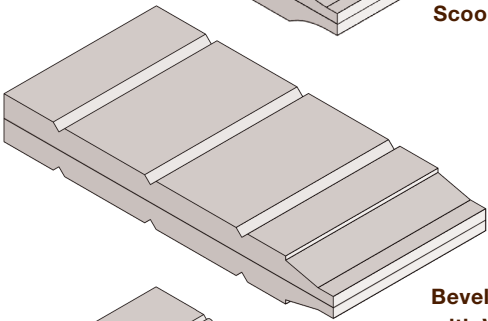

Bevel Panel with V-Groove

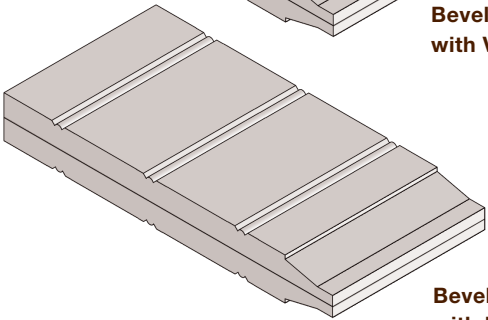

Bevel Panel with Bead

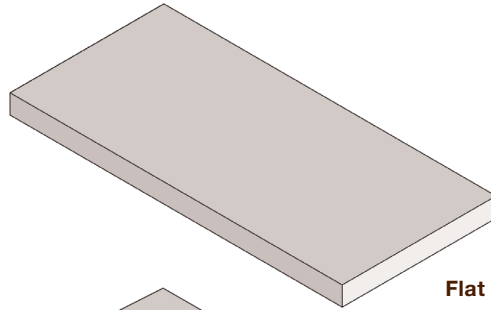

Flat Panel

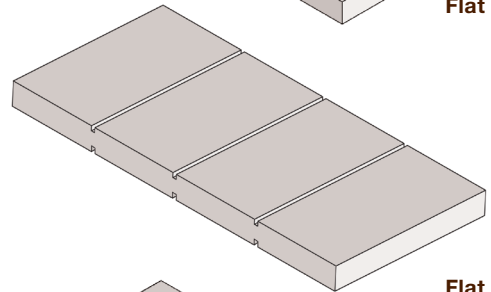

Flat Panel with Square Groove
(for exterior use the square groove will stop short of the rails)

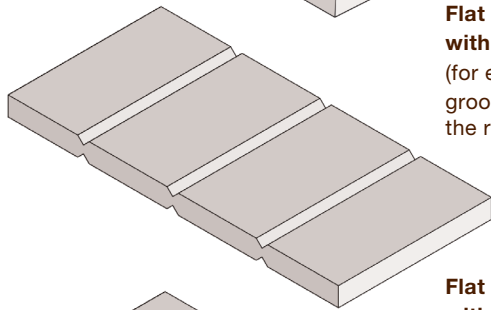

Flat Panel with V-Groove
(for exterior use the v-groove will stop short of the rails)

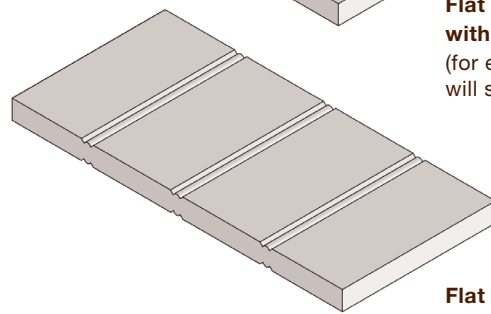

Flat Panel with Bead
(for exterior use the bead will stop short of the rails)



Double Panel Design

Our double panel technology virtually eliminates cracking panels by allowing independent movement of wood surfaces exposed to different humidity and temperature conditions on each side of the door. The implementation of our double panel design on all our raised panel doors has enhanced their appearance and performance, especially doors used in exterior applications. We are able to offer many doors with different species on each door face.

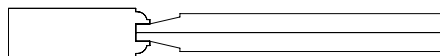

Sticking options.

Captiva offers a wide array of sticking profile options for all of our wood doors. Each door style is available in the sticking options shown.

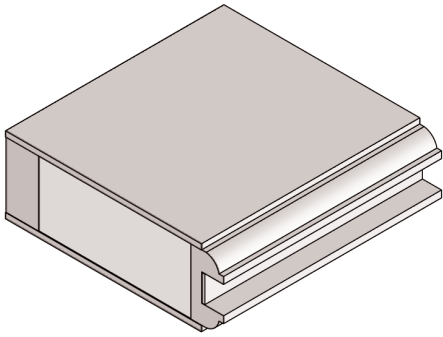

Ovolo Sticking

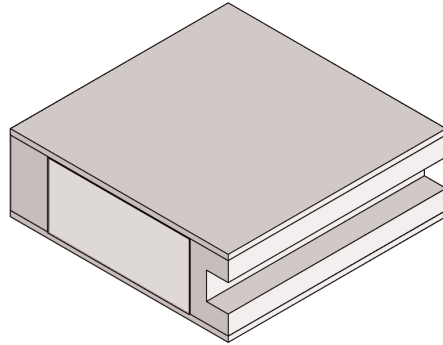

Square Sticking

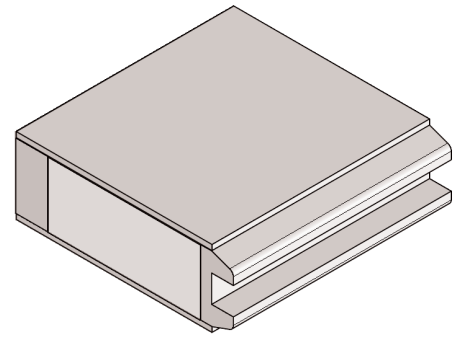

Bevel Sticking

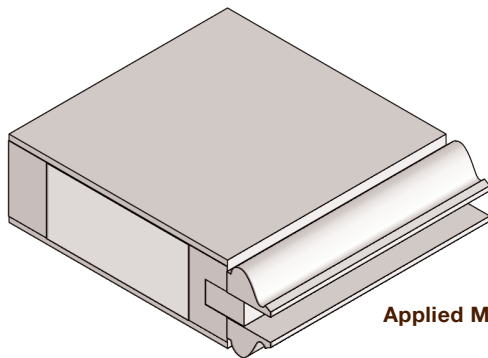

Applied Moulding

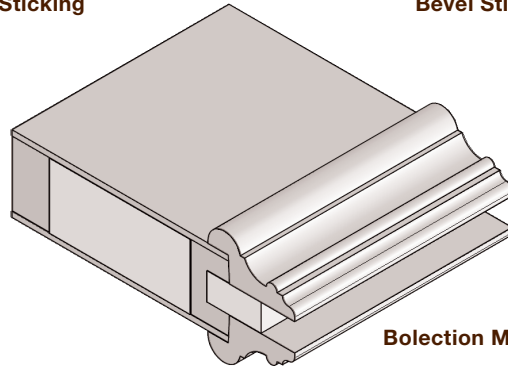

Bolection Moulding

Common panel and sticking combinations:

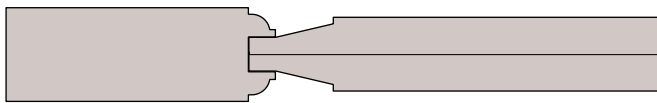

Ovolo Sticking with Bevel Panel



Square Sticking with Flat Panel

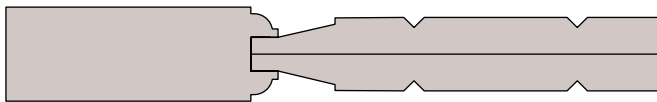

Ovolo Sticking with V-Groove Bevel Panel

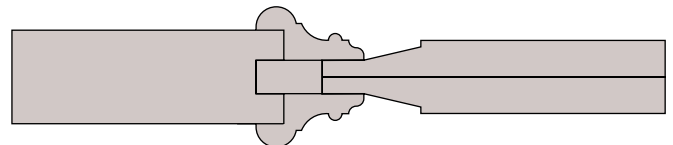

Bolection Moulding Sticking with Bevel Panel

Custom panel or sticking.

If you do not see a panel or sticking option that meets your requirements, send us a sketch and we will match it.

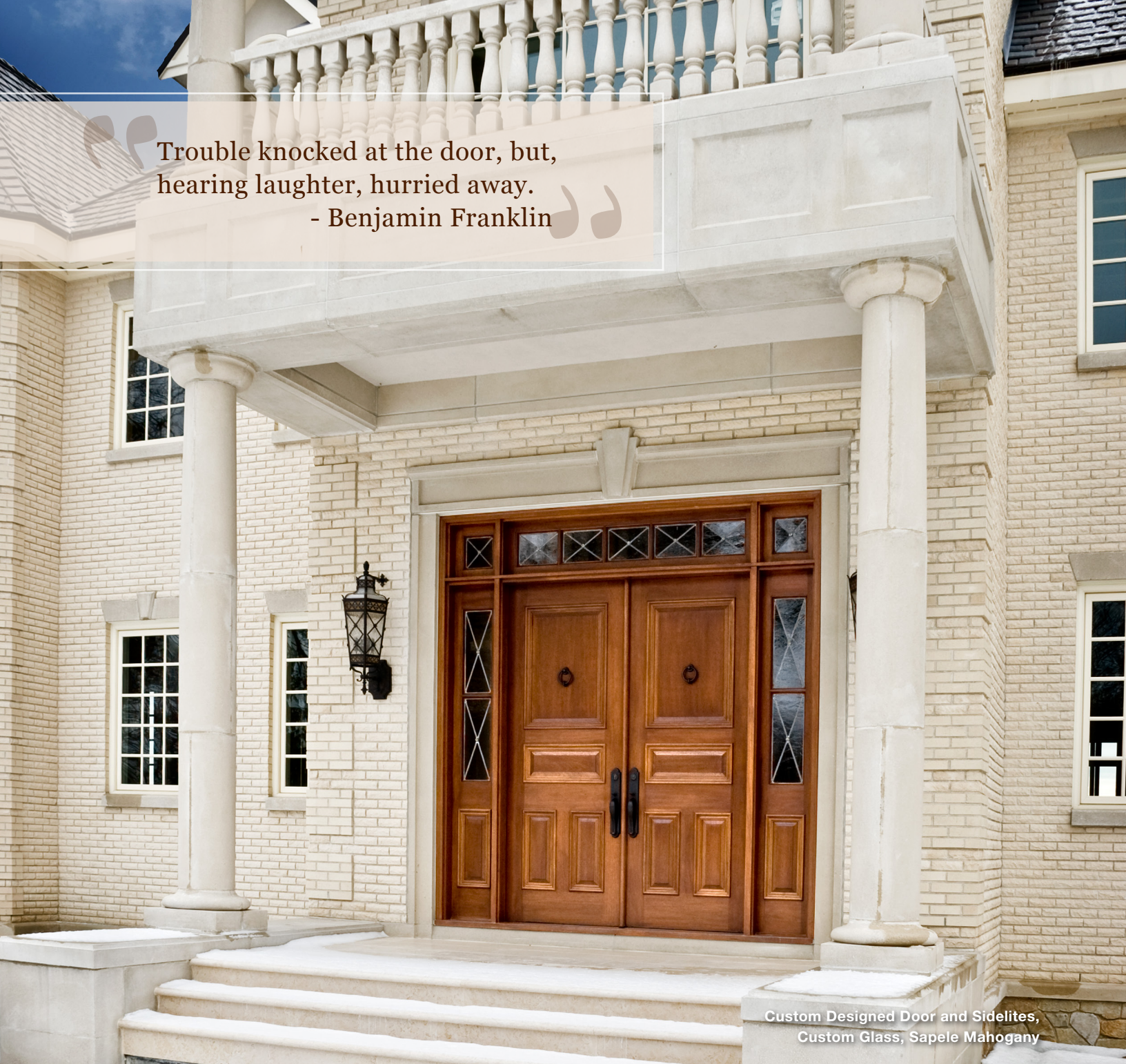

Trouble knocked at the door, but,
hearing laughter, hurried away.
- Benjamin Franklin

Custom Designed Door and Sidelites,
Custom Glass, Sapele Mahogany

Panel doors.

THE CLASSIC PANEL DOOR. WITH OVER ONE HUNDRED PANEL DOOR DESIGNS TO CHOOSE FROM, ALLOW YOUR IMAGINATION TO RUN WILD. ALL OF OUR PANEL DOOR DESIGNS ARE AVAILABLE IN BOTH OUR SELECT AND TRADITIONAL SERIES AND ARE WELL SUITED FOR BOTH INTERIOR AND EXTERIOR USE. IF YOU DON'T SEE THE DESIGN YOU'RE LOOKING FOR, PROVIDE US WITH A DRAWING, PHOTOGRAPH, OR ROUGH SKETCH AND WE WILL CUSTOM DESIGN THE DOOR OF YOUR DREAMS. WHEN YOU CHOOSE CAPTIVA WOOD DOORS, THE POSSIBILITIES ARE ENDLESS.



CAPTIVA
wood doors

Panel door designs.

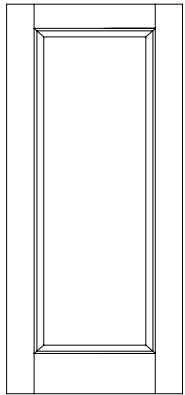

8001

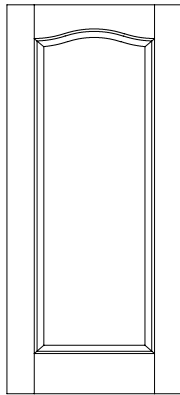

8002

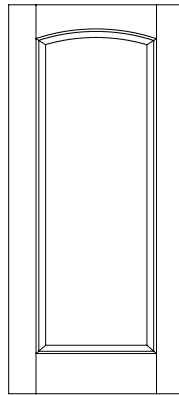

8003

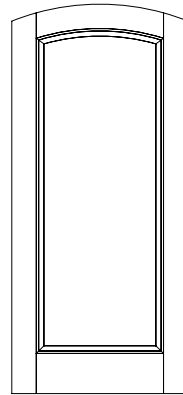

8003A

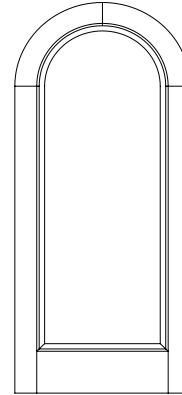

8004R

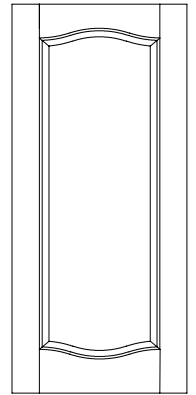

8005

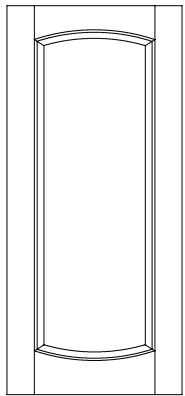

8006

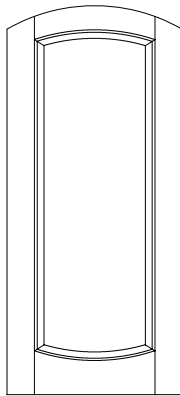

8006A

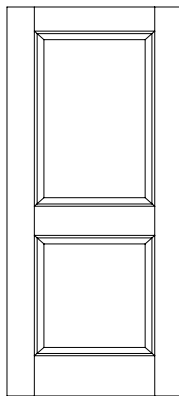

8007

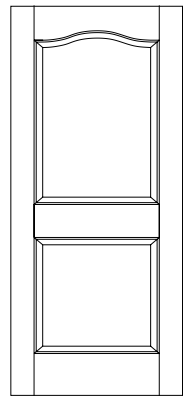

8008

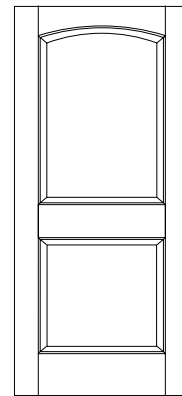

8009

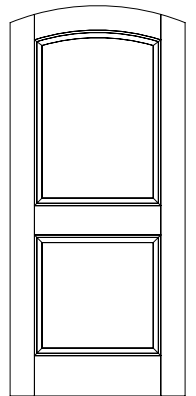

8009A

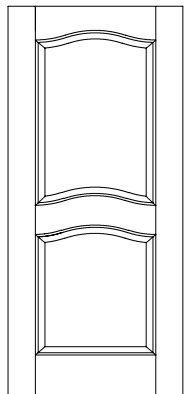

8010

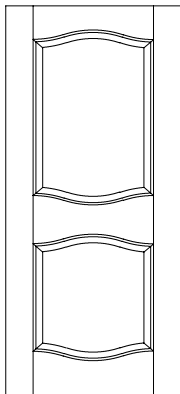

8011

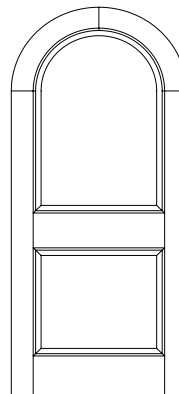

8014R

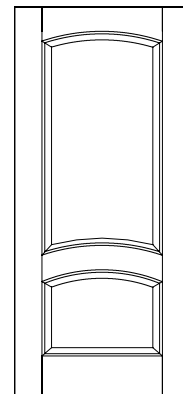

8015

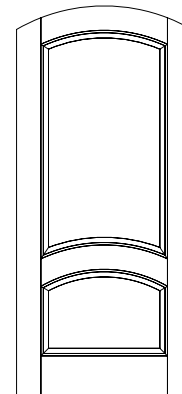

8015A

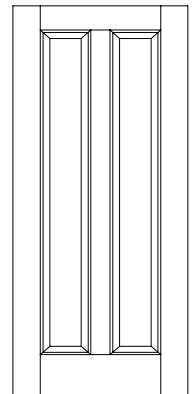

8016

Quick Ship, see page 13

Arched Top available

Square Top available

Round Top available

Double Door Arched Pair available, see pages 38-39

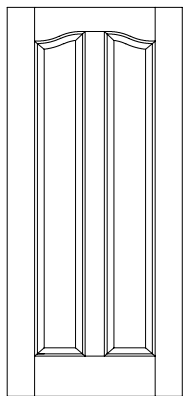

8017

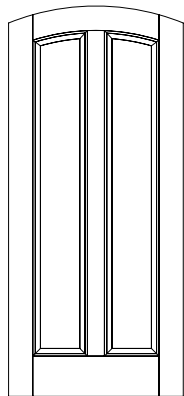

8018A

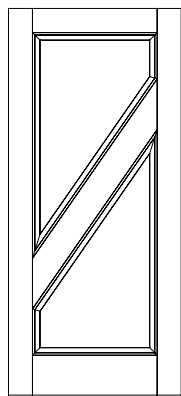

8019

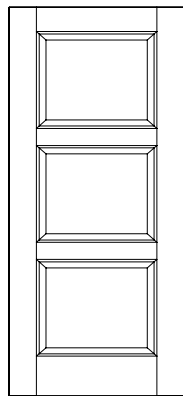

8020

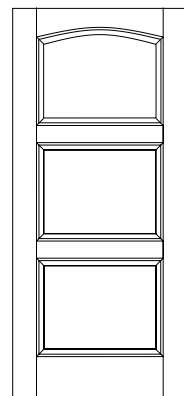

8021

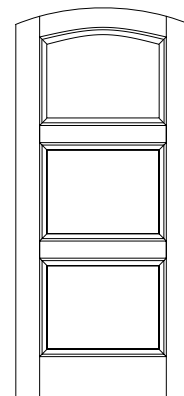

8021A

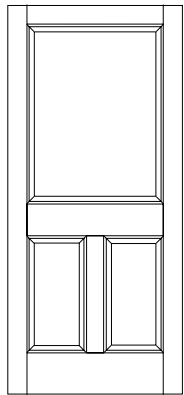

8022

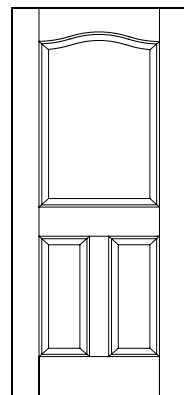

8023

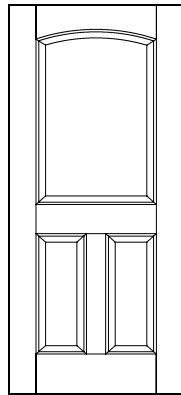

8024

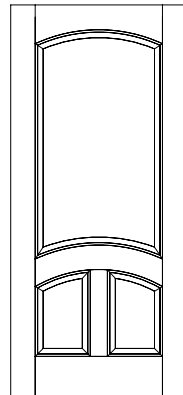

8025

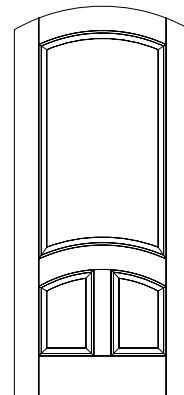

8025A

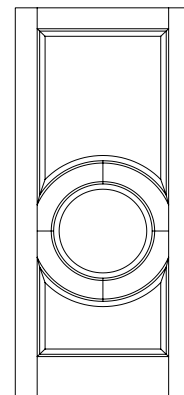

8026

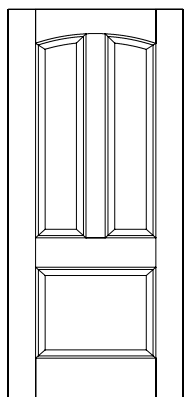

8027

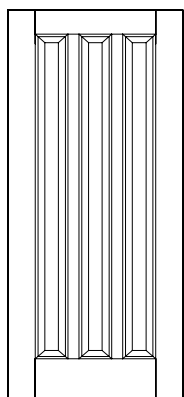

8028

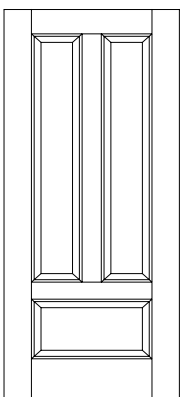

8029

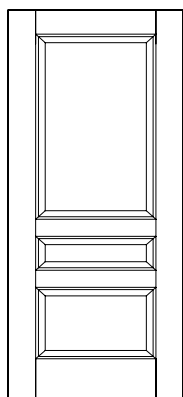

8030

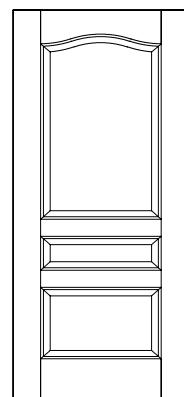

8031

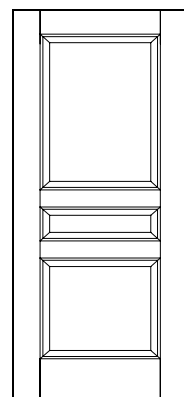

8032

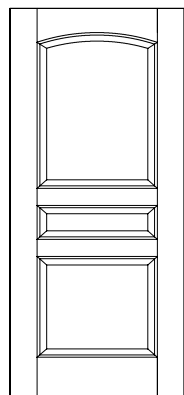

8033

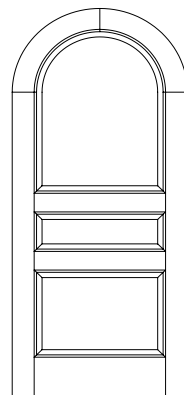

8034R

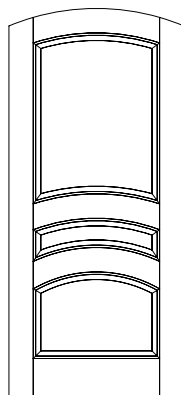

8035A

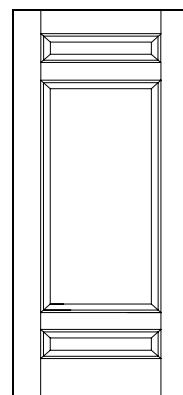

8036

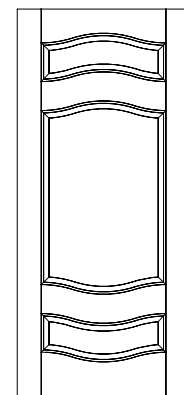

8037

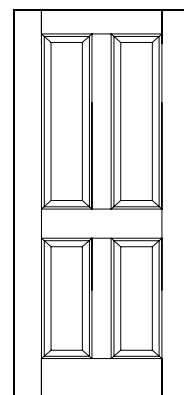

8038

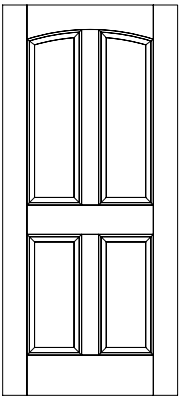

8039   

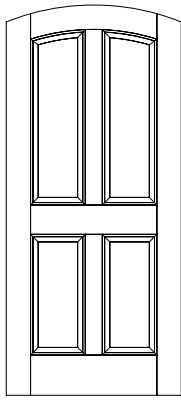

8039A  

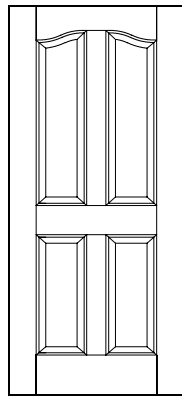

8040 

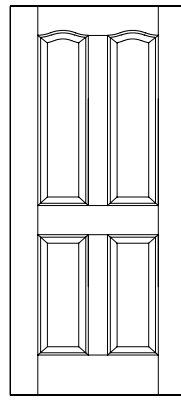

8041

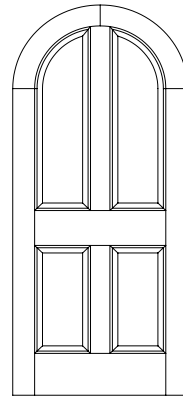

8042R  

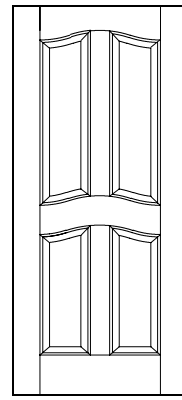

8043 

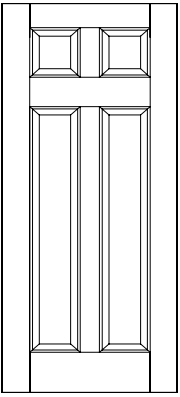

8044 

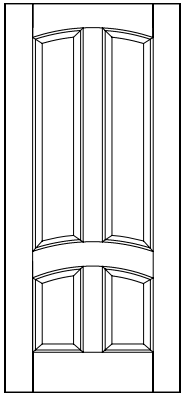

8045   

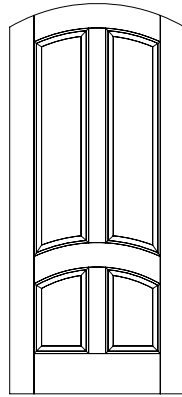

8045A  

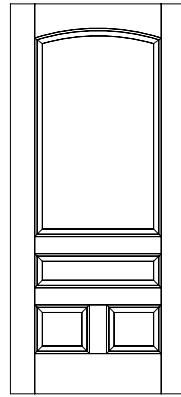

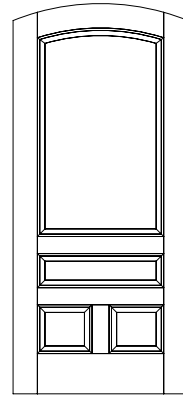

8046  

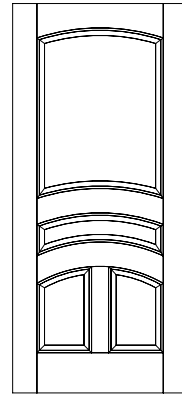

8046A  



8047   

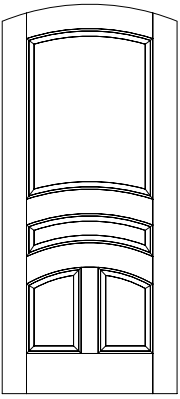

8047A  

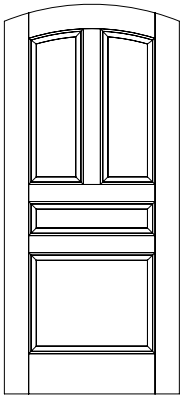

8048A  

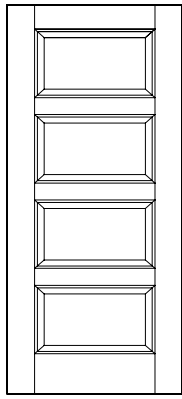

8049 

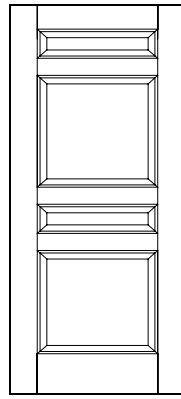

8050 

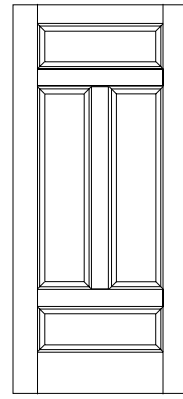

8051 

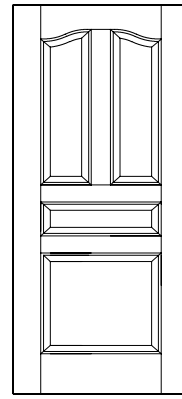

8052 

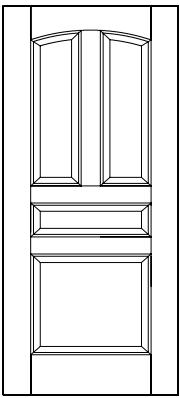

8053   

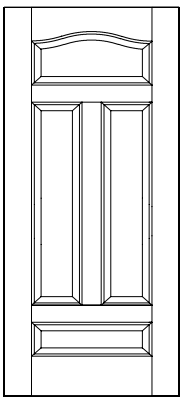

8054 

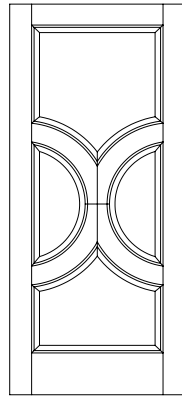

8056

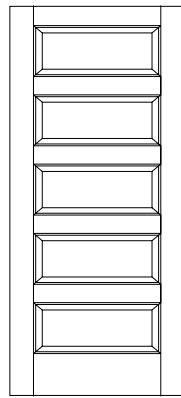

8057 

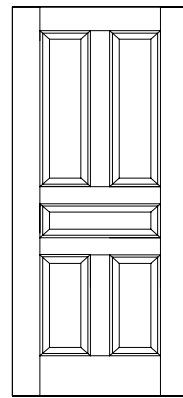

8058 

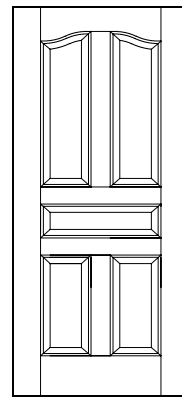

8059 

 Quick Ship, see page 13  Arched Top available

 Square Top available

 Round Top available

 Double Door Arched Pair available, see pages 38-39

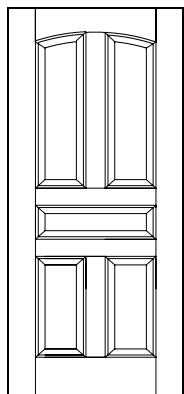

8060  

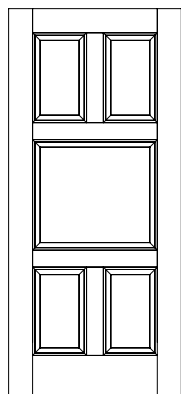

8061 

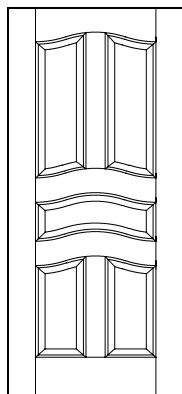

8062 

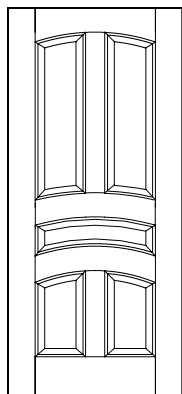

8063   

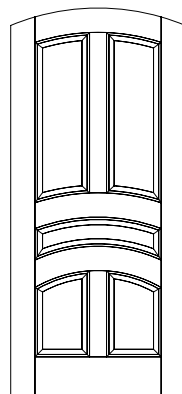

8063A  

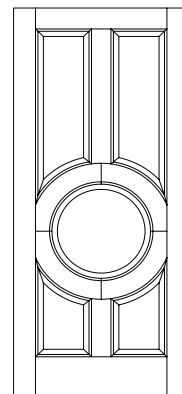

8064

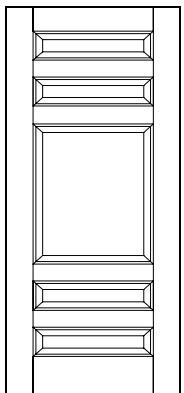

8065 

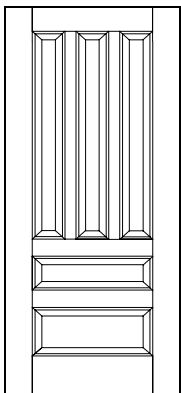

8066 

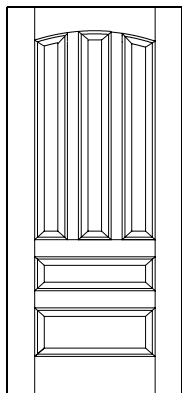

8067   

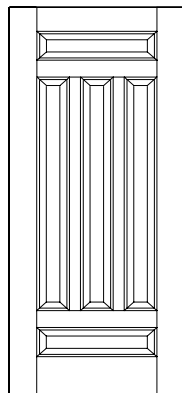

8068 

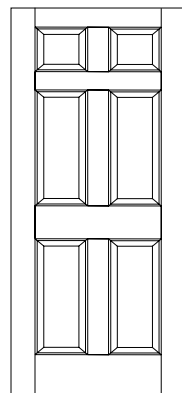

8069 

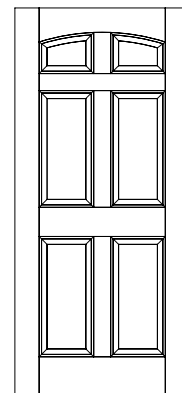

8070   

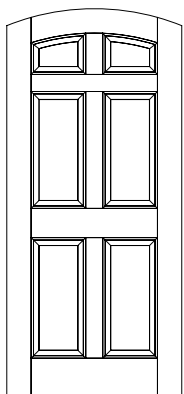

8070A  

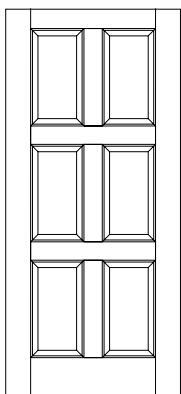

8071 

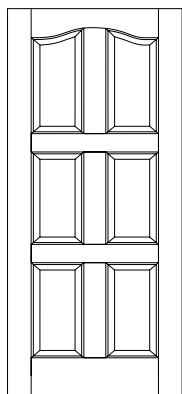

8072 

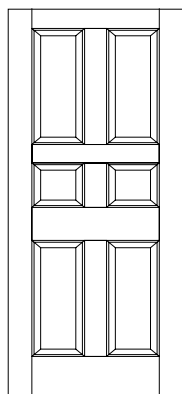

8073 

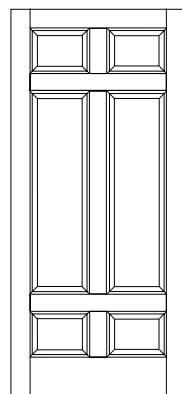

8074 

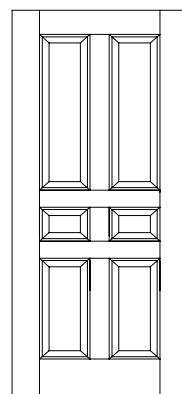

8075

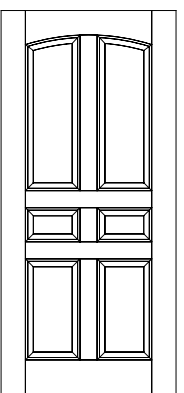

8076  

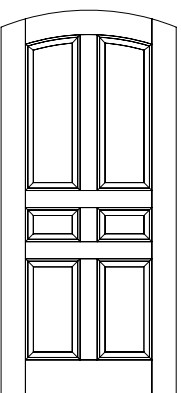

8076A  

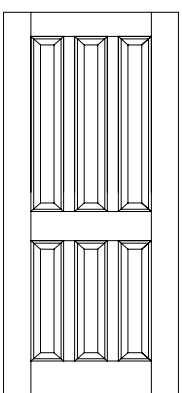

8077 

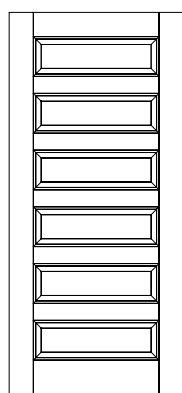

8078 

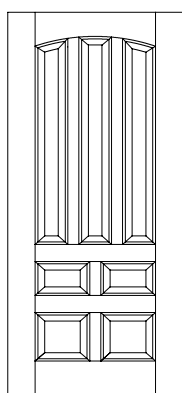

8079  

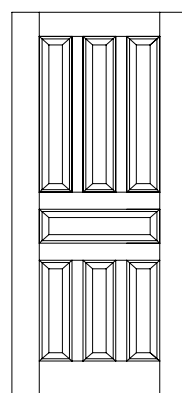

8080 

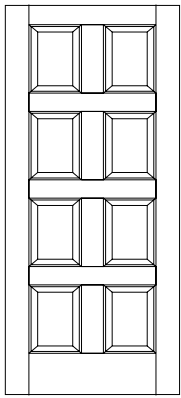

8081

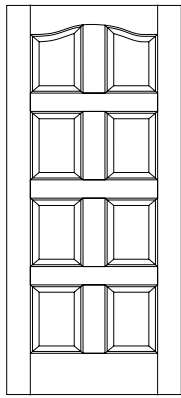

8082

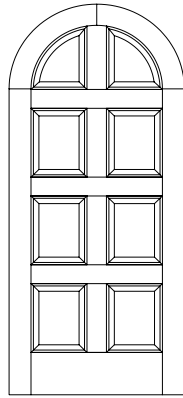

8083R

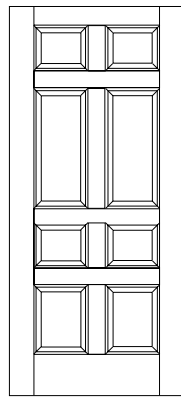

8084

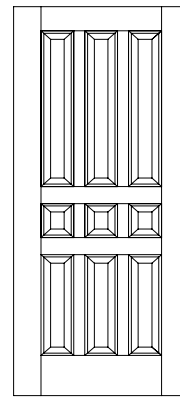

8085

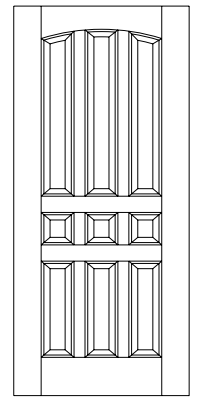

8086

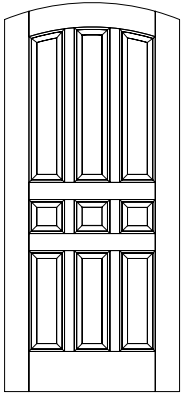

8086A

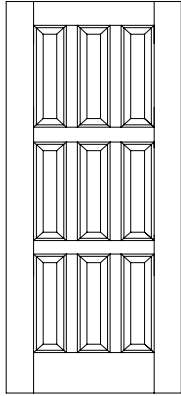

8087

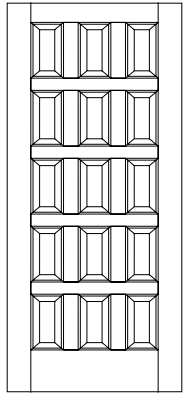

8088

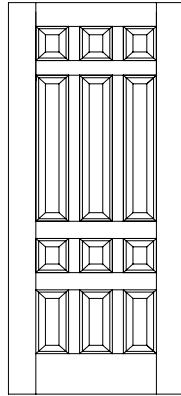

8089

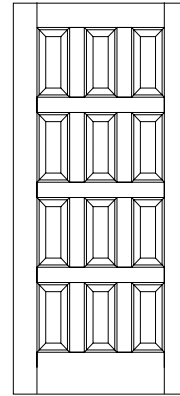

8090

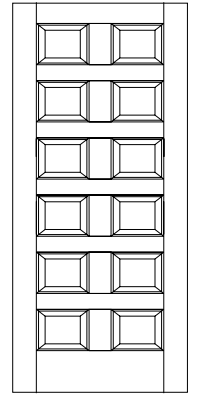

8091



CAPTIVA
wood doors

Louver doors.

Available with square sticking only.

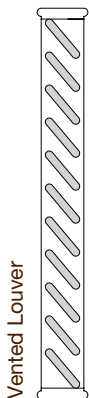

Vented Louver

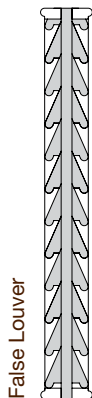

False Louver

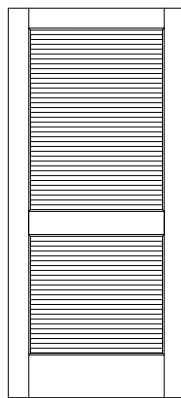

8140

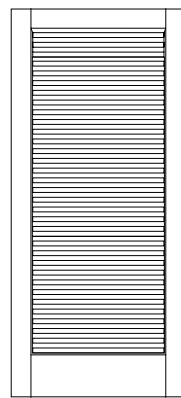

8141

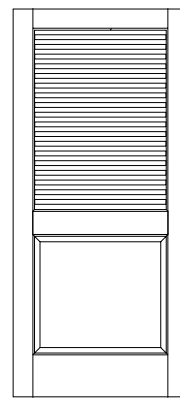

8142

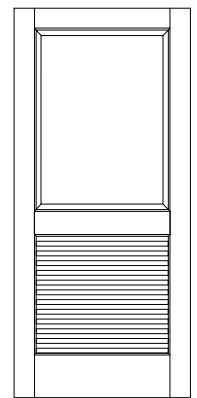

8143

The closing of a door can bring blessed privacy and comfort – the opening, terror. Conversely, the closing of a door can be a sad and final thing – the opening a wonderfully joyous moment.

- Andy Rooney



8601 Double Door Units with 8751 Transoms, Sapele Mahogany

Glass doors.

Single Pane Glass

Suggested for interior use only, our 1/8" single strength tempered glass is available for all our glass door designs (see opposite page for details and availability).

Insulated Glass

For exterior applications, we use 5/8" tempered insulated glass with optional LoE and/or argon gas. Choose between True Divided Lite and Simulated Divided Lite (see opposite page for details and availability).

Muntin Bars

With three profiles to choose from — Ovolo, Square, and Bevel — muntin bars typically match the door's sticking (see opposite page for details and availability).

Decorative Glass

When your project requires a special order decorative glass, provide us with a sketch, picture, or idea and we will call on our glass suppliers from around the country to find the particular glass that you desire.

Glass options.

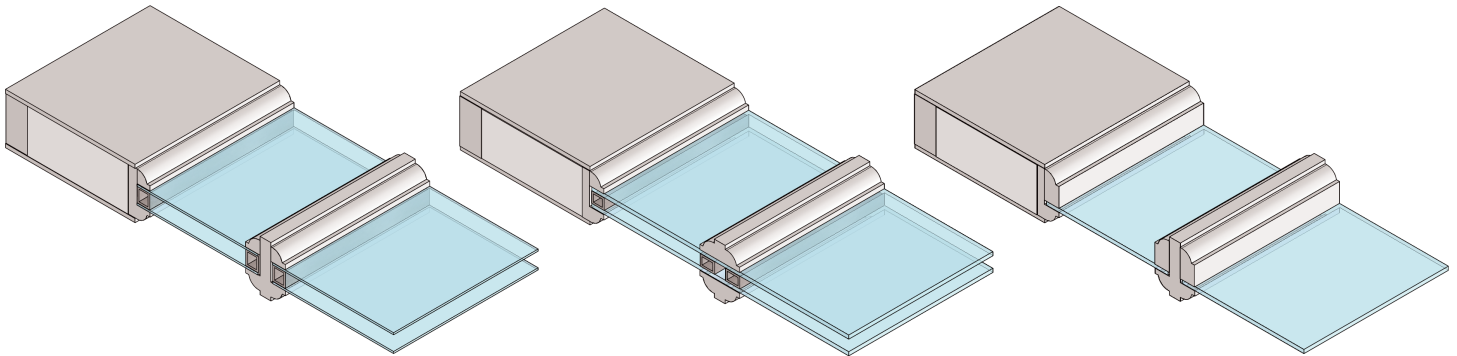

Insulated Glass
True Divided Lite (TDL)

Insulated Glass
Simulated Divided Lite (SDL)
Captiva Select Doors only

Single Pane Glass
True Divided Lite (TDL)

Muntin bar options and availability.

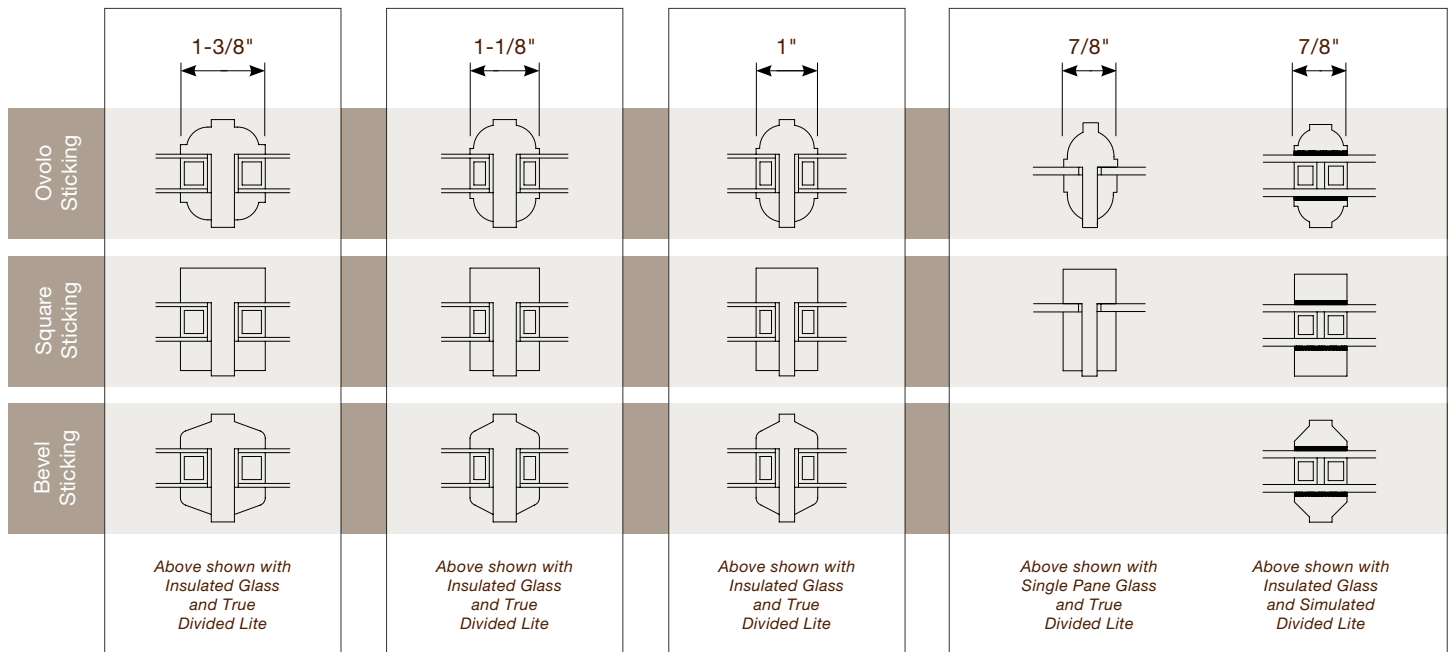

	Door Thickness	1-3/4" Doors				2-1/4" Doors				1-3/8" Doors			
	Muntin Bar Width	1-3/8"	1-1/8"	1"	7/8"	1-3/8"	1-1/8"	1"	7/8"	1-3/8"	1-1/8"	1"	7/8"
Captiva Select Doors													
True Divided Lite with Insulated Glass		OBS	OBS	OBS		OBS	OBS	OBS		S	OS	OS	
Simulated Divided Lite with Insulated Glass					OBS				OS				
True Divided Lite with Single Pane Glass		OBS	OBS	OBS		OBS	OBS	OBS		S	OS	OS	S
Captiva Traditional Doors													
True Divided Lite with Insulated Glass		OBS	OBS	OBS		OBS	OBS	OBS		S	OS	OS	
True Divided Lite with Single Pane Glass		OBS	OBS	OBS	OS	OBS	OBS	OBS	S	S	OS	OS	OS

O = Ovolo Sticking, B = Bevel Sticking, S = Square Sticking

Specialty glass options.



SPECIALTY GLASS CAN PROVIDE PRIVACY, FILTER LIGHT OR SIMPLY MAKE A DRAMATIC STATEMENT. BELOW ARE SOME OF THE MOST POPULAR STYLES OF SPECIALTY GLASS FROM ARCHITECTURAL GLASS EFFECTS. FROM TRADITIONAL TO MODERN, OUR GLASS SUPPLIERS HAVE HUNDREDS OF STYLES TO MEET YOUR NEEDS.



Frosted



Bevel



Bark



Chinchilla



Ribbed



Everglade



Spotlite



Stippled



Crepe



Eng Flemish



Glue Chip



Double Chip



Rain



Mirage



Cobblestone



Linen



Water



Mesa



Drift



Loom



Bamboo



Bubbly



Aqui



Confetti

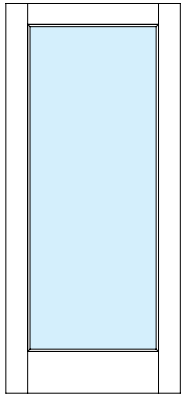

8601

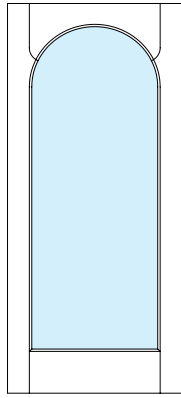

8602

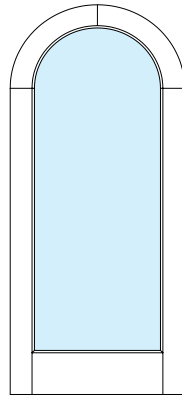

8602R

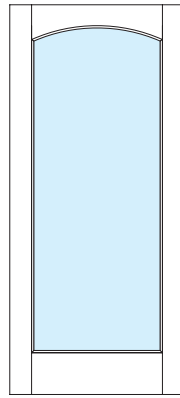

8603

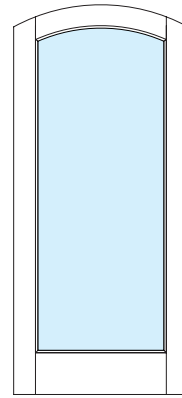

8603A

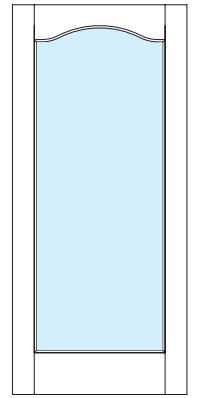

8604

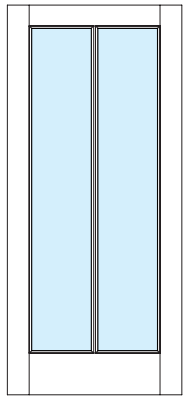

8605

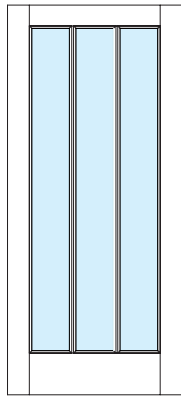

8606

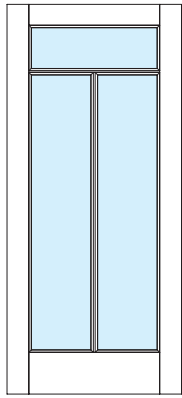

8607

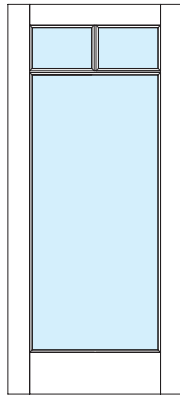

8608

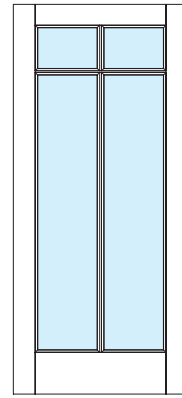

8609

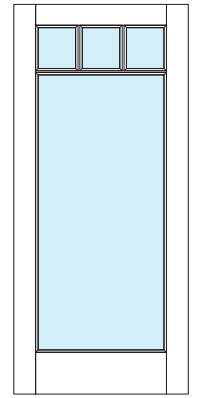

8610

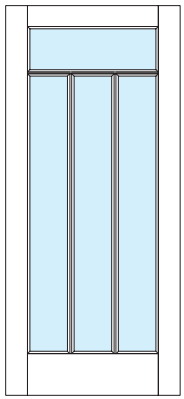

8611

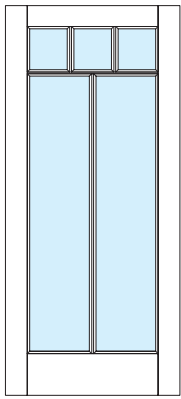

8612

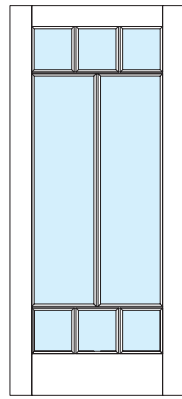

8613

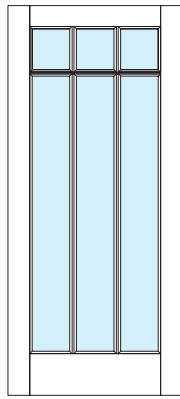

8614

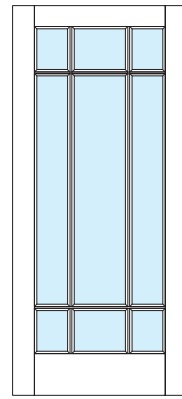

8615

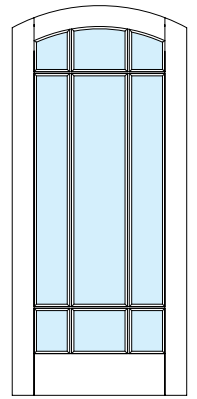

8616A

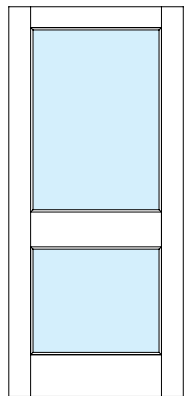

8617

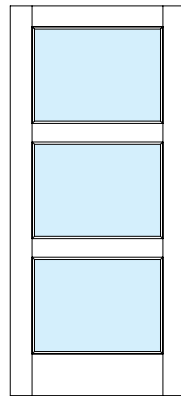

8618

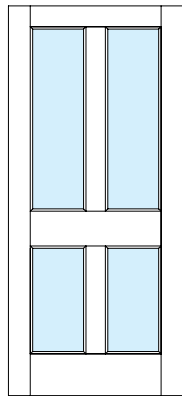

8619

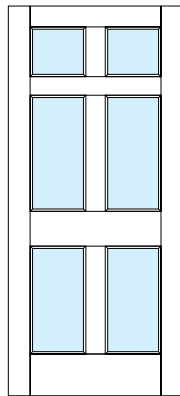

8620

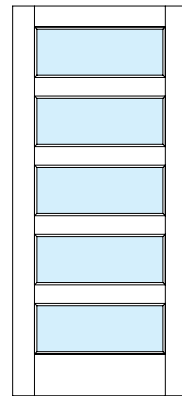

8621

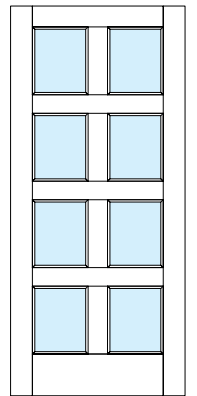

8622

Quick Ship, see page 13

Arched Top available

Double Door Arched Pair available, see pages 38-39

Square Top available

Round Top available

*Not available with SDL internal spacer.

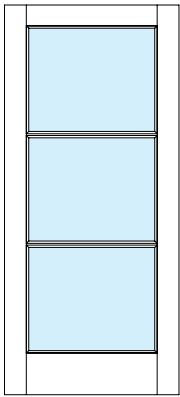

8623 

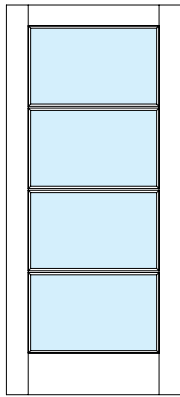

8624 

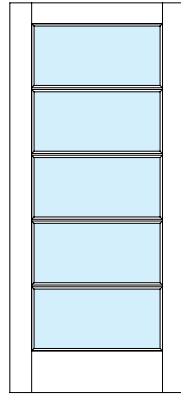

8625 

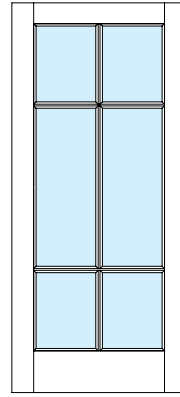

8626 

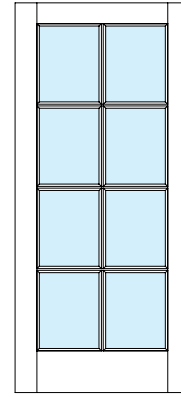

8627 

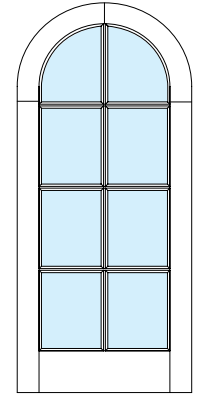

8628R  

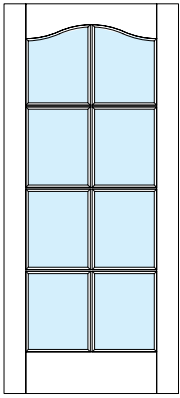

8629 

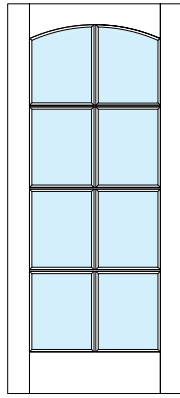

8630   

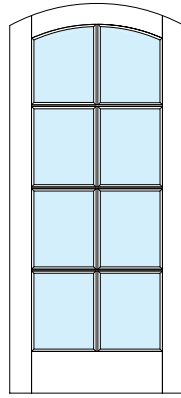

8630A  

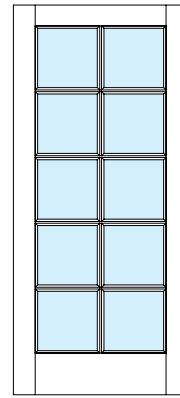

8631 

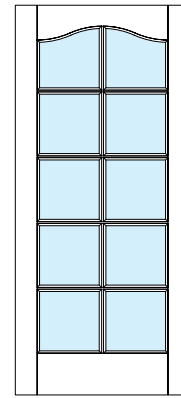

8632 

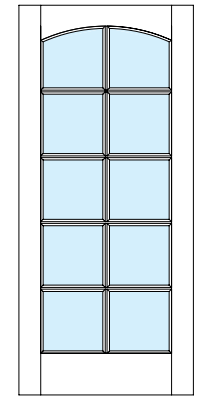

8633   

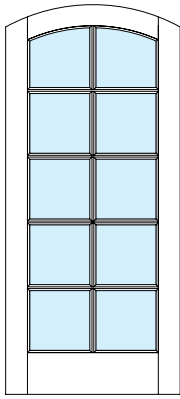

8633A  

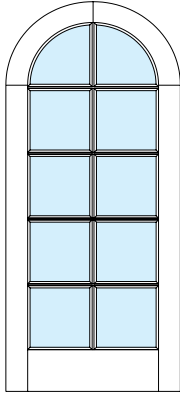

8634R  

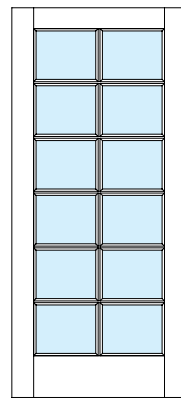

8635 

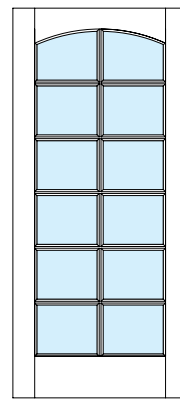

8636   

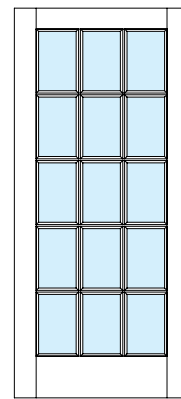

8637 

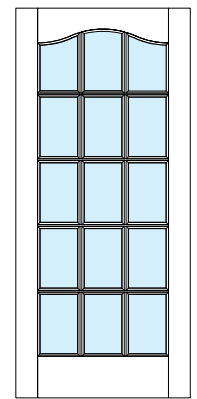

8638 

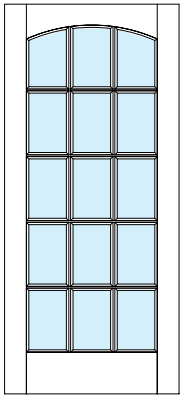

8639   

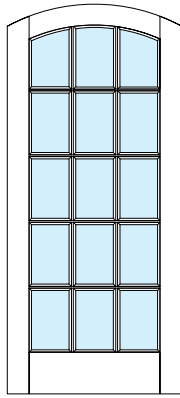

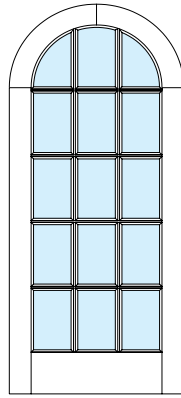

8639A  

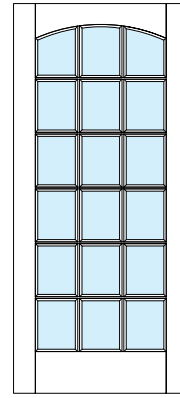

8640R  



8641   

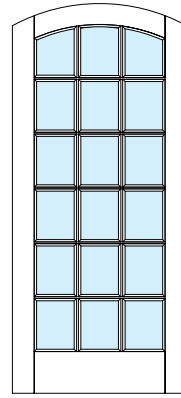

8641A  

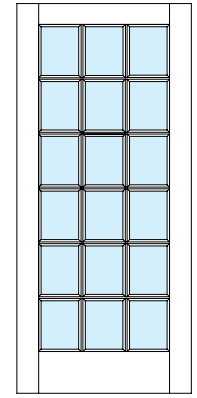

8642 

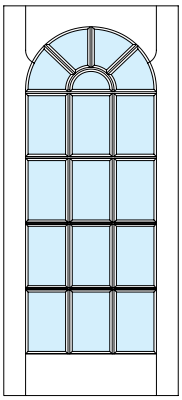

8643* 

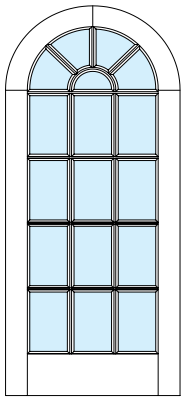

8643R* 

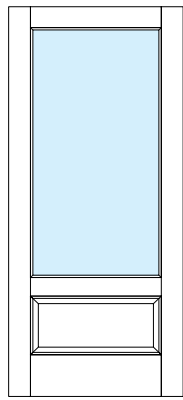

8301 

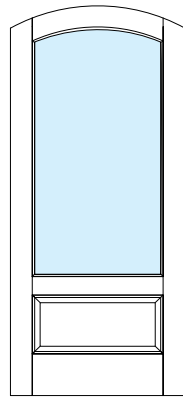

8302A 

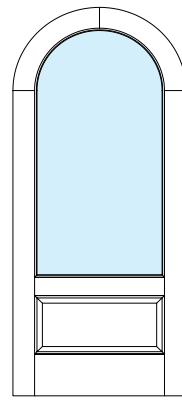

8303R 

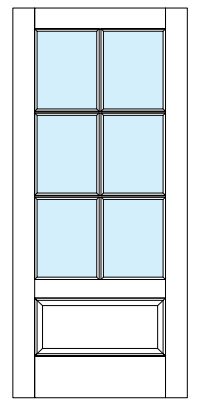

8304 

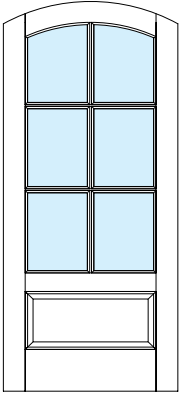

8305A 

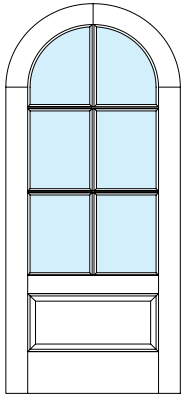

8306R 

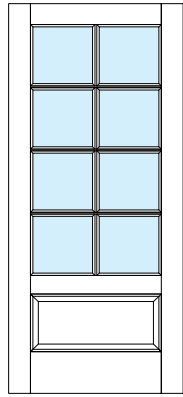

8307 

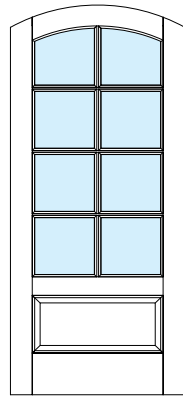

8308A 

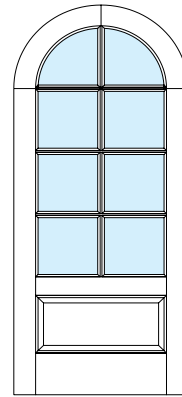

8309R 

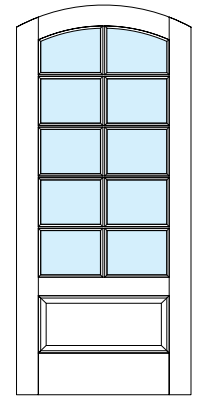

8310A 

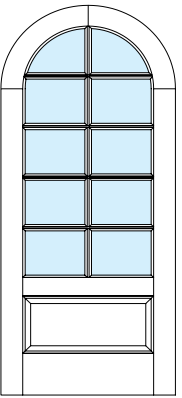

8311R 

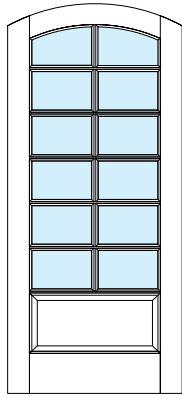

8312A 

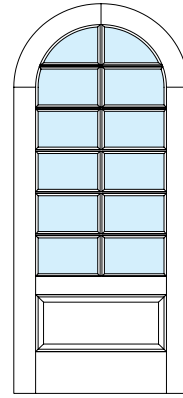

8313R 

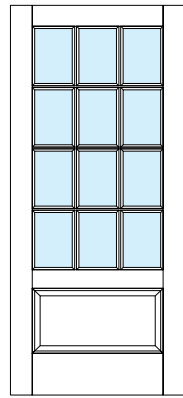

8314 

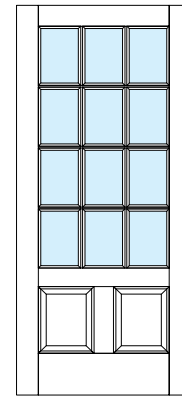

8315 

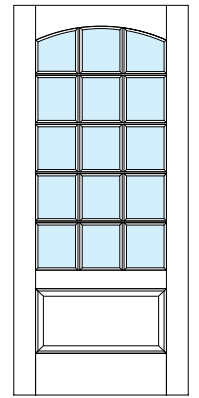

8316  

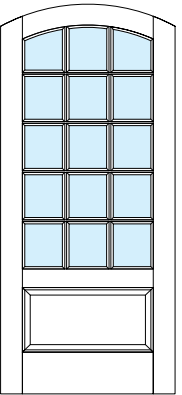

8316A 

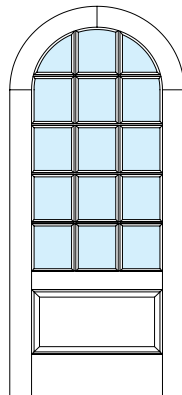

8317R 

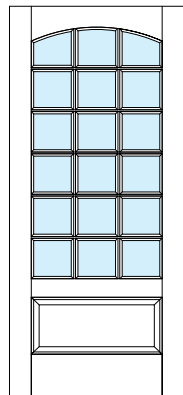

8318  

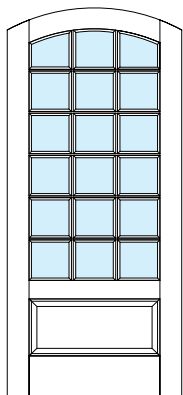

8318A 

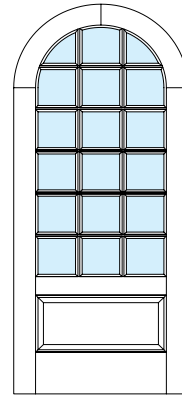

8319R 

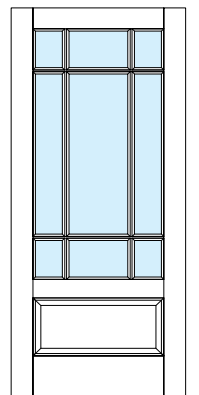

8320 

 Quick Ship, see page 13

 Arched Top available

 Double Door Arched Pair available, see pages 38-39

 Square Top available

 Round Top available

*Not available with SDL internal spacer.

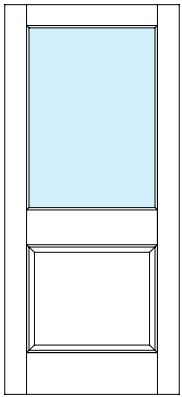

8321 

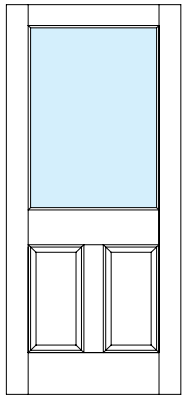

8322 

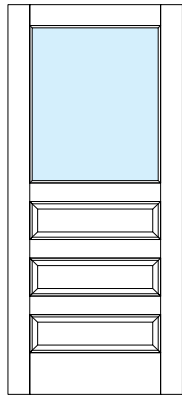

8323 

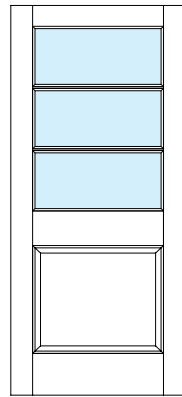

8324 

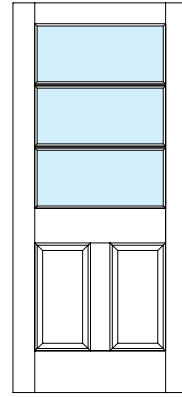

8325 

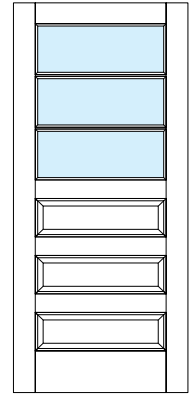

8326 

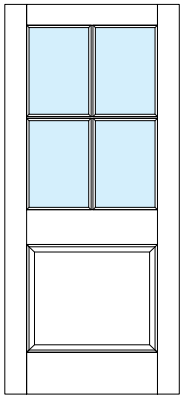

8327 

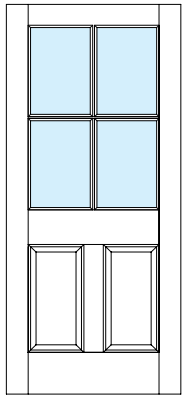

8328 

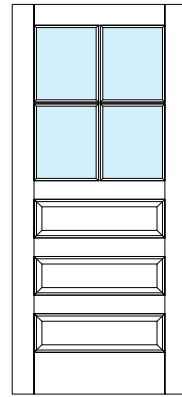

8329 

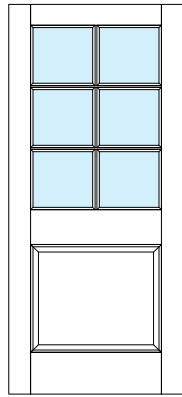

8330 

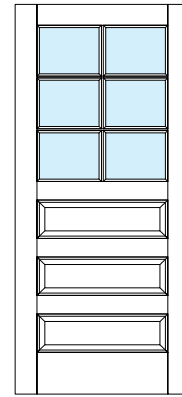

8331 

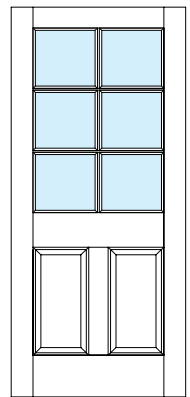

8332 

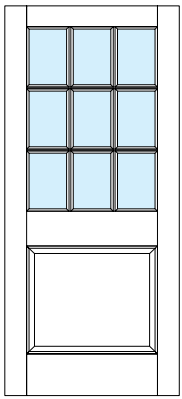

8333 

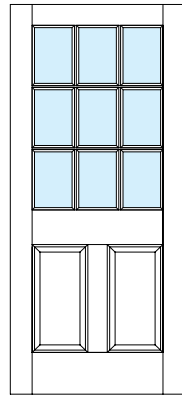

8334 

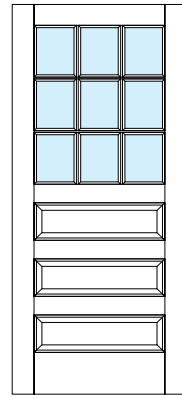

8335 

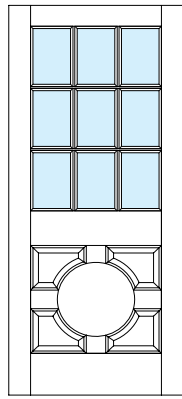

8336

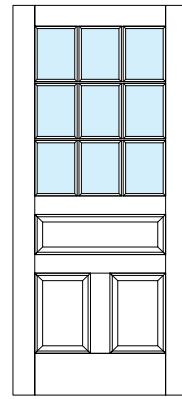

8337 

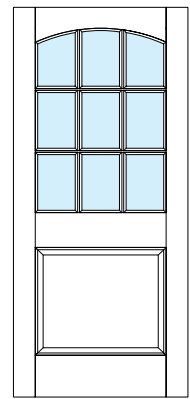

8338   

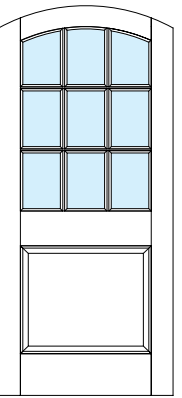

8338A  

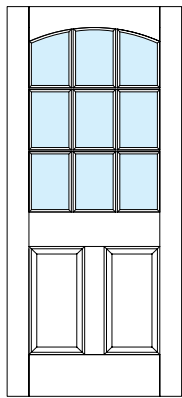

8339   

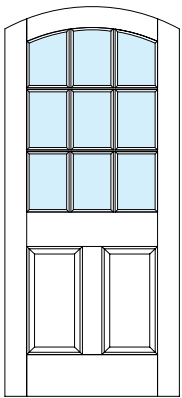

8339A  

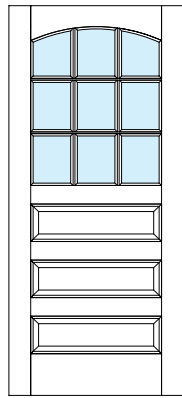

8340   

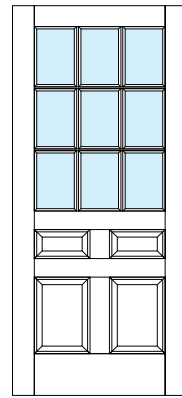

8341 

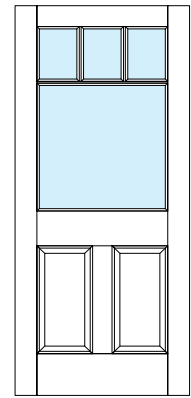

8342 

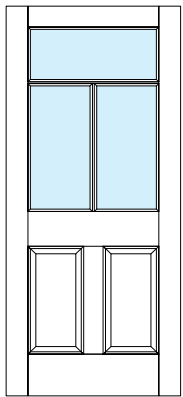

8343 

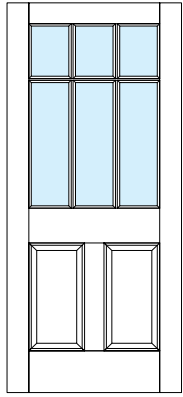

8344 

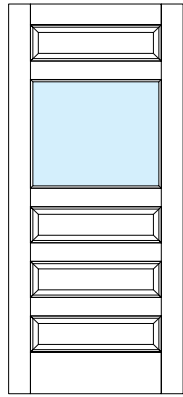

8345 

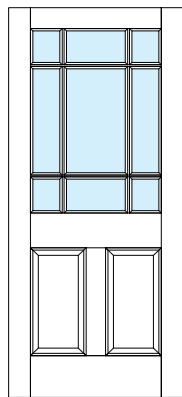

8346 

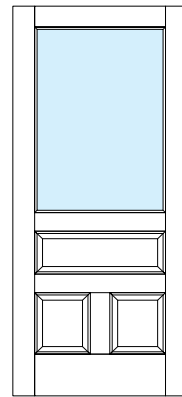

8347 

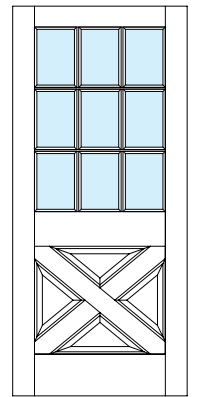

8348

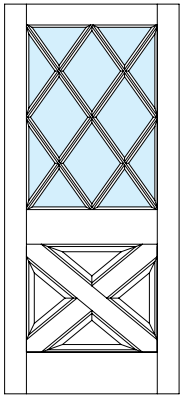

8349*

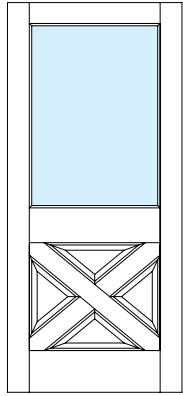

8350

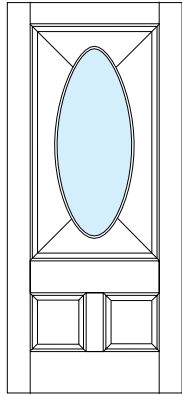

8351

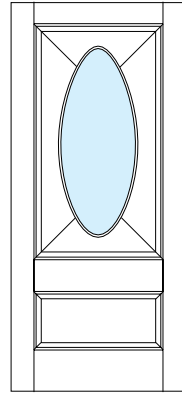

8352

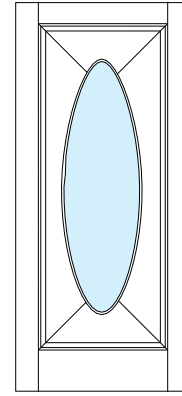

8353

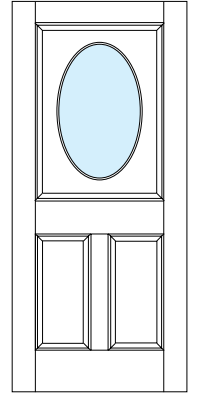

8354

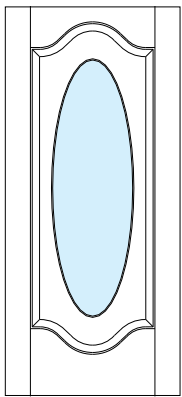

8355

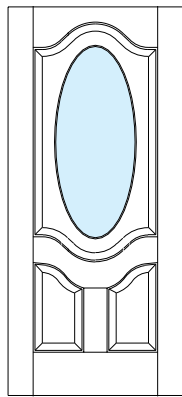

8356

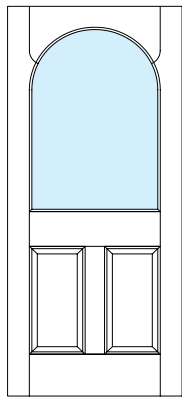

8357  

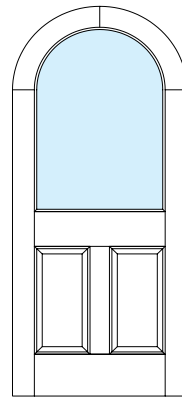

8357R  

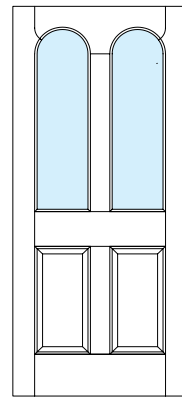

8358

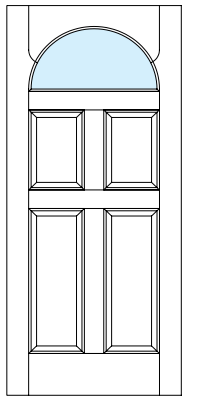

8359 

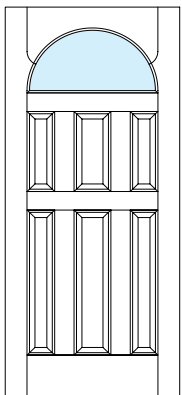

8360 

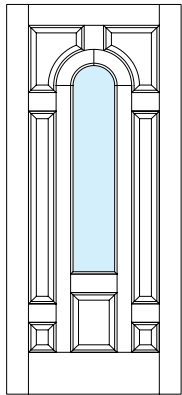

8361

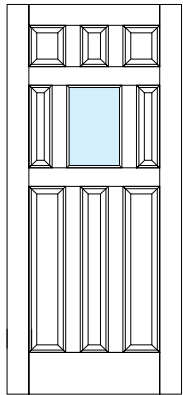

8362

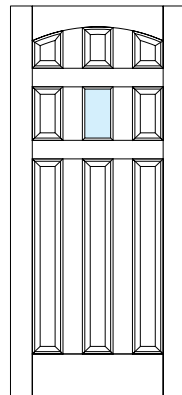

8363 

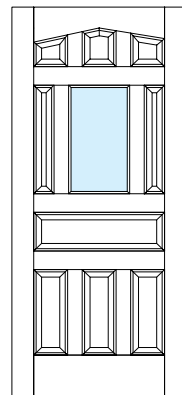

8364

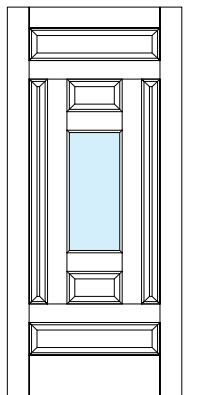

8365

 Quick Ship, see page 13

 Arched Top available

 Double Door Arched Pair available, see pages 38-39

 Square Top available

 Round Top available

*Not available with SDL internal spacer.

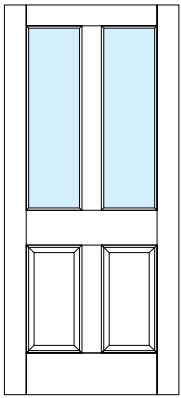

8366

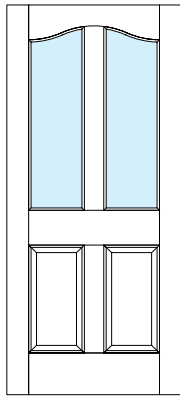

8367

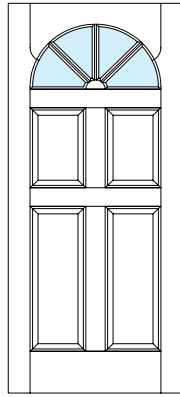

8368*

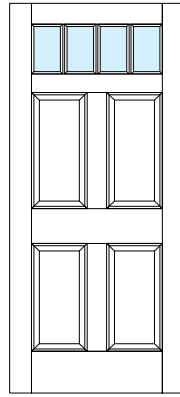

8369

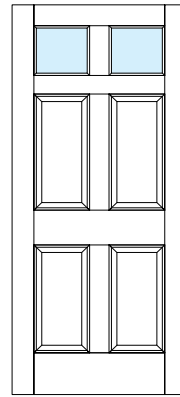

8370

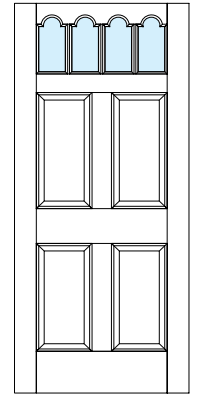

8371

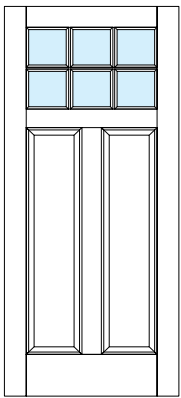

8372

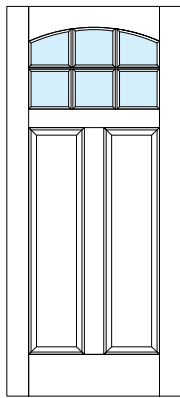

8373

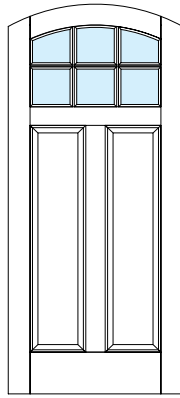

8373A

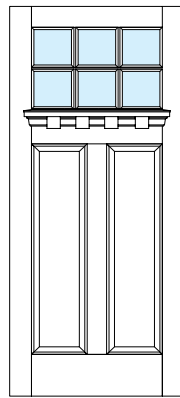

8374

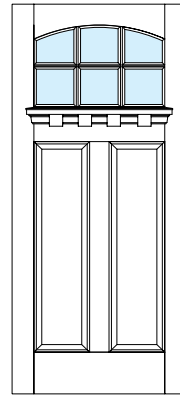

8375

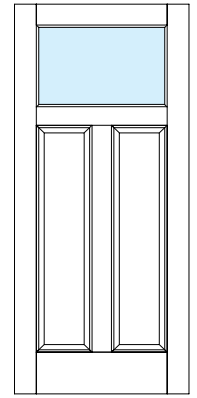

8376

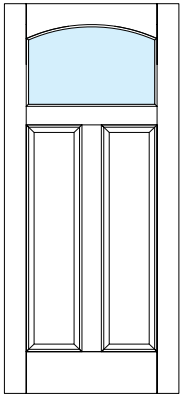

8377

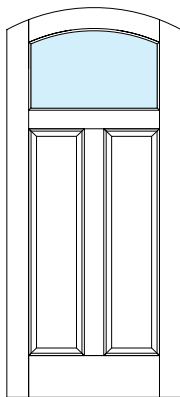

8377A

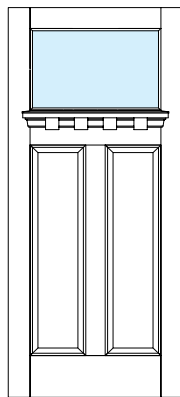

8378

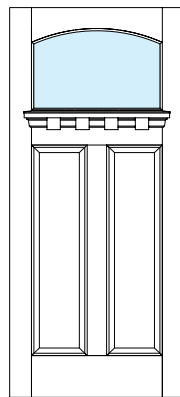

8379

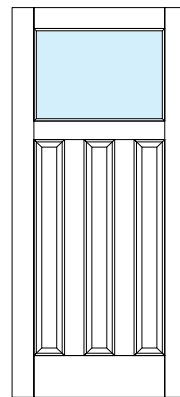

8380

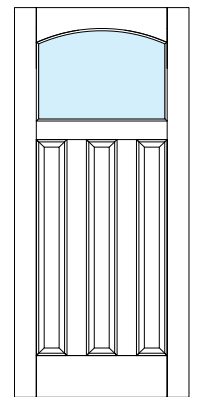

8381

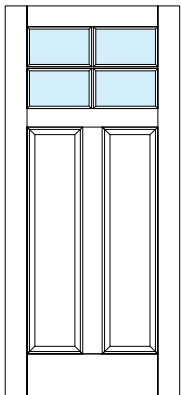

8382

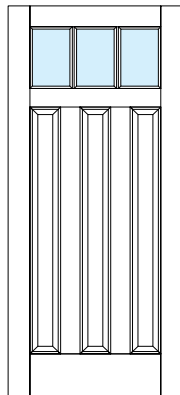

8383

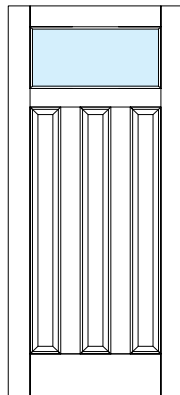

8384

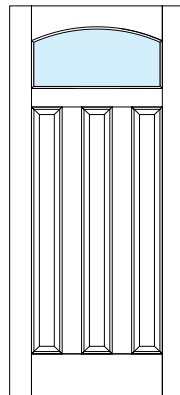

8385

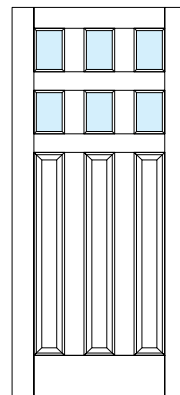

8386

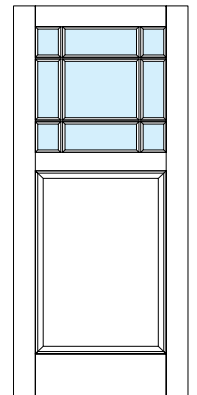

8387

Quick Ship, see page 13

Arched Top available

Double Door Arched Pair available, see pages 38-39

Square Top available

Round Top available

*Not available with SDL internal spacer.



Modified 8372 Door, Modified 8708 Sidelites and Modified 8756 Transom, Sapele Mahogany



Custom-Designed Door, Sidelites and Transom, Sapele Mahogany



8372 Door with Custom Sidelites, Sapele Mahogany



Modified 8009 Double Door Unit, Sapele Mahogany

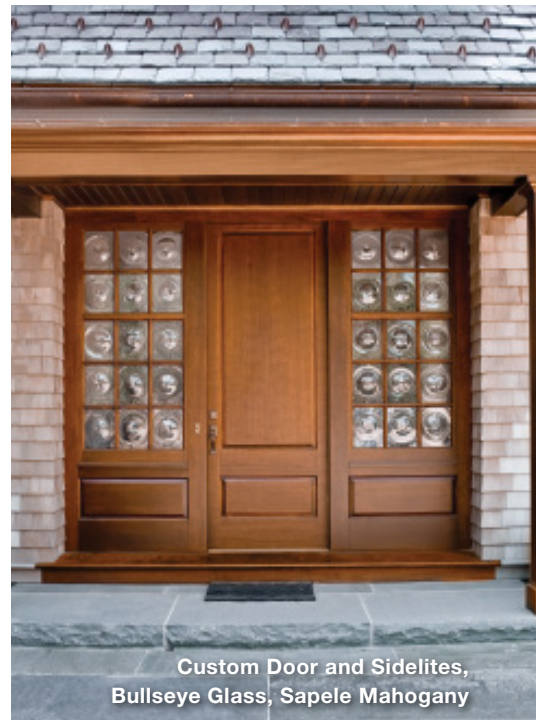

Custom Door and Sidelites, Bullseye Glass, Sapele Mahogany



8039A Door with Custom Sidelites, Sapele Mahogany

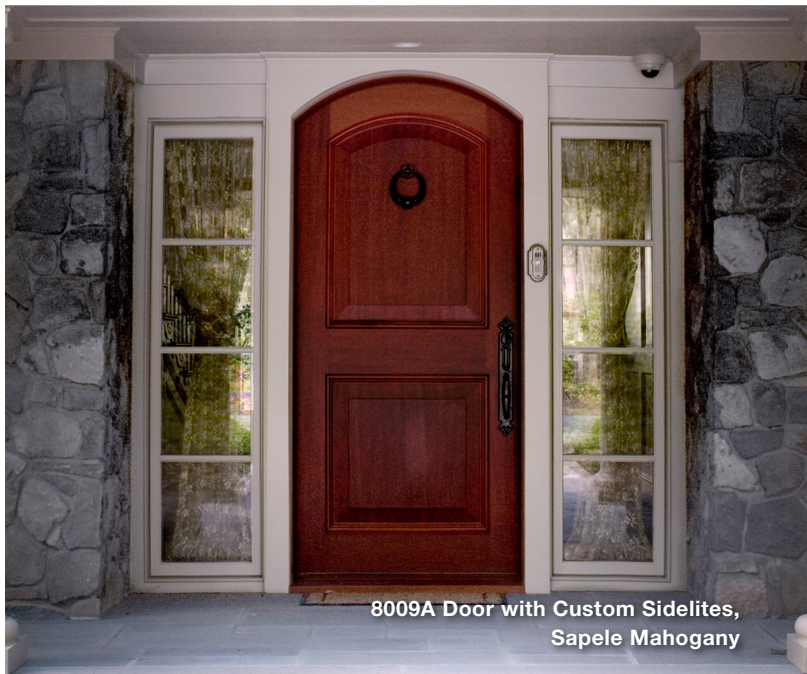

8009A Door with Custom Sidelites, Sapele Mahogany



photo by Richard Mandelkorn

Captiva modern collection.

THE CAPTIVA MODERN COLLECTION OFFERS CLEAN LINES AND CONTEMPORARY PATTERNS WITHOUT SACRIFICING THE BEAUTY AND WARMTH OF A WOOD DOOR. DEPENDING ON THE DESIGN, THESE DOORS ARE EITHER STILE AND RAIL CONSTRUCTION OR FLUSH CONSTRUCTION. FLUSH DOORS ARE AVAILABLE AS SQUARE-GROOVED ONLY.

Modern door designs.

The following designs are only available in Square Groove. See page 36 for detailed image.
Stile and rail construction unless otherwise noted as Flush (F).

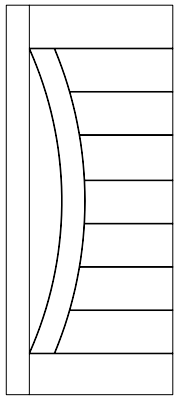

8093 F

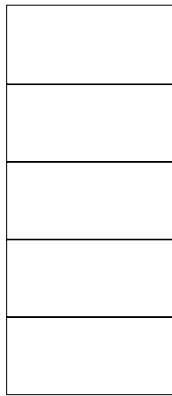

8094 F

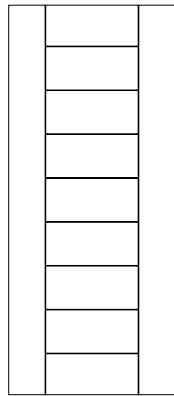

8095 F

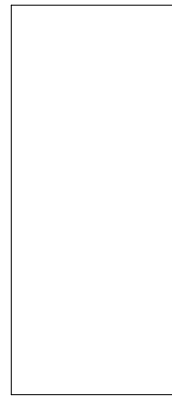

8096 F

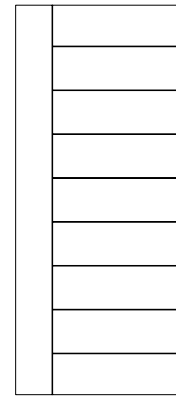

8097 F

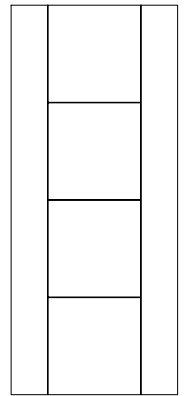

8098 F

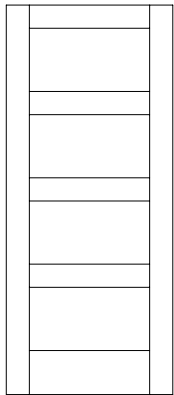

8122

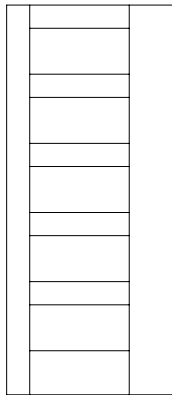

8123

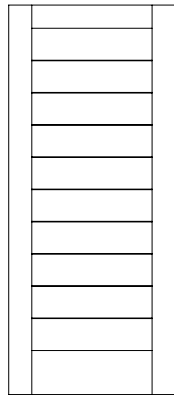

8124

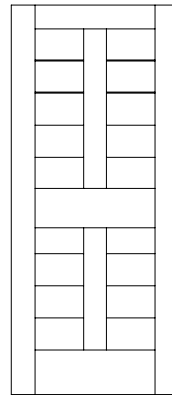

8125

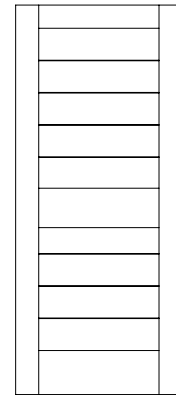

8126

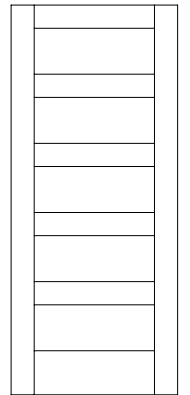

8127

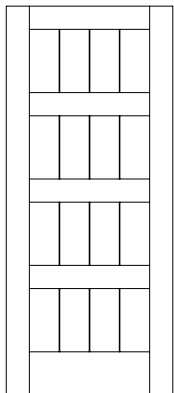

8128

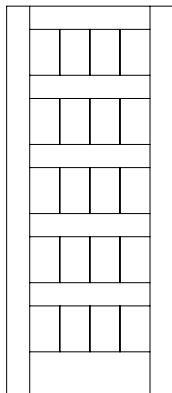

8129

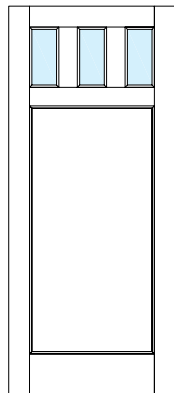

8435

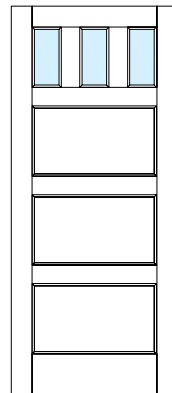

8436

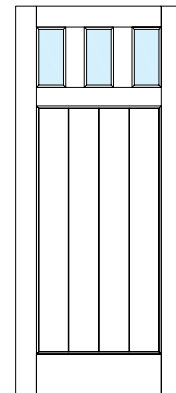

8437

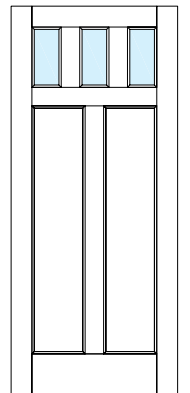

8438

F - Flush construction

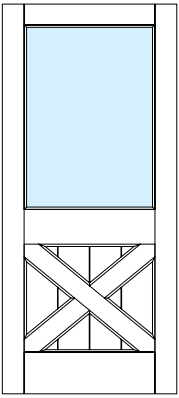

8439

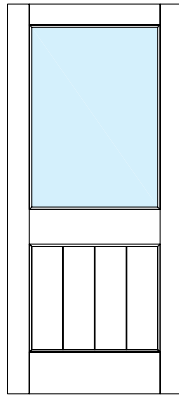

8440

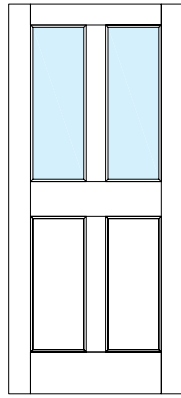

8441

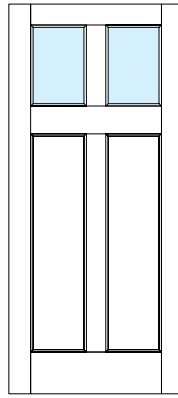

8442

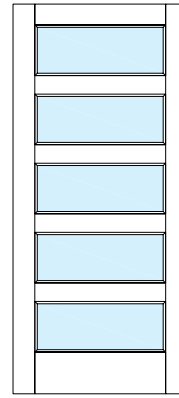

8443

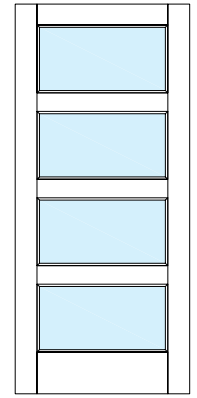

8444

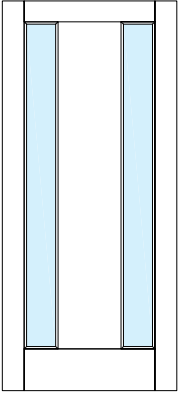

8398

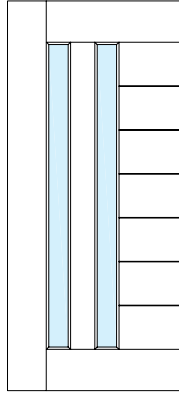

8399 *F*

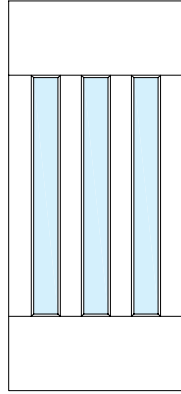

8400 *F*

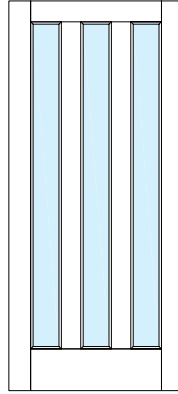

8401

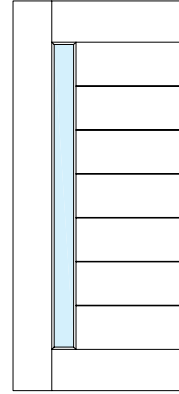

8402 *F*

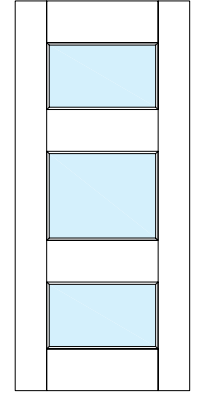

8403

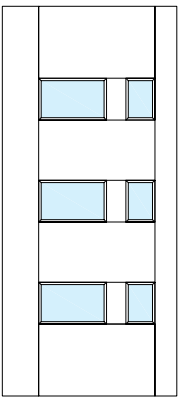

8404

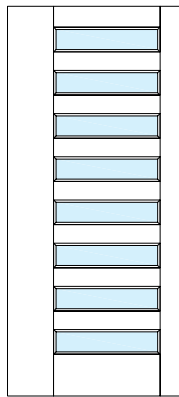

8405

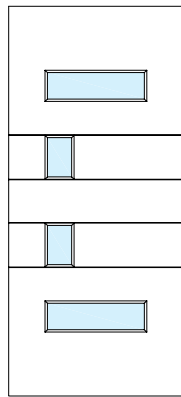

8406 *F*

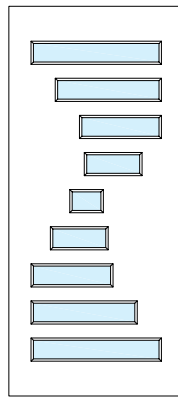

8407 *F*

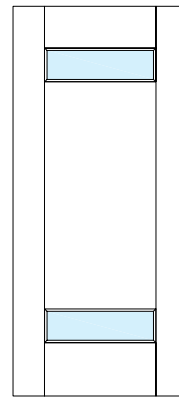

8408

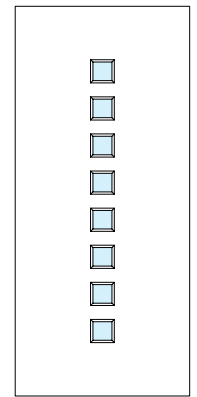

8409 *F*

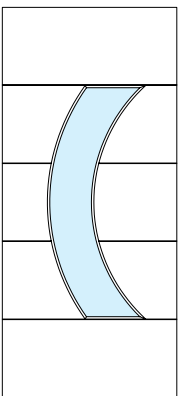

8410 *F*

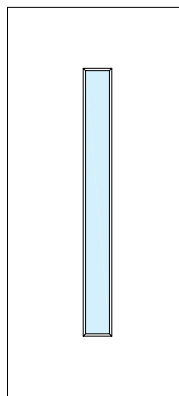

8411 *F*

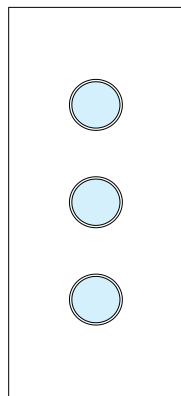

8412 *F*

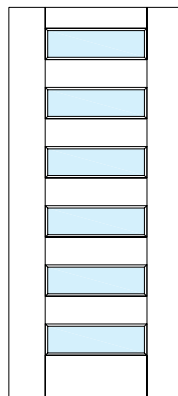

8413

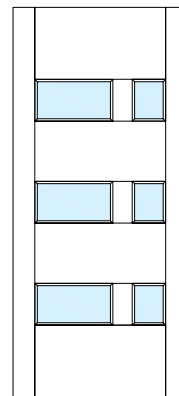

8414

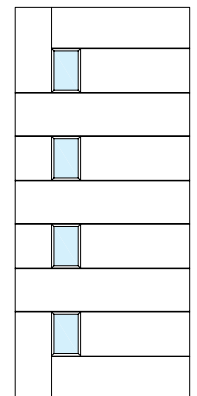

8415 *F*

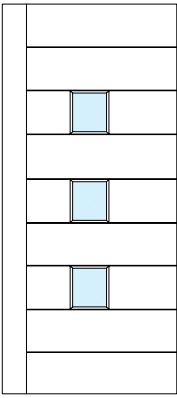

8416 F

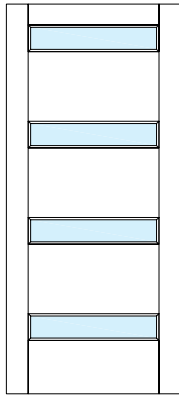

8417

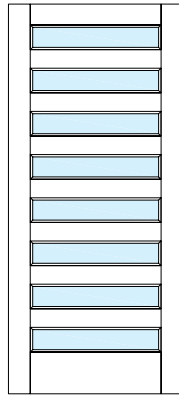

8418

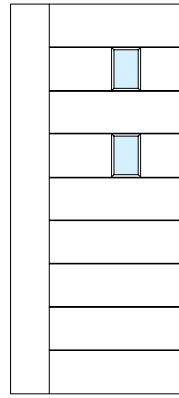

8419 F

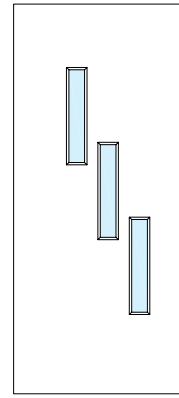

8420 F

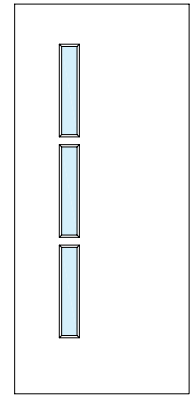

8421 F

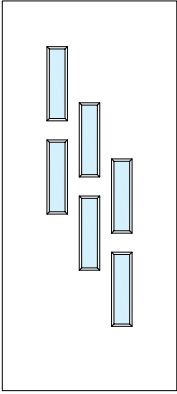

8422 F

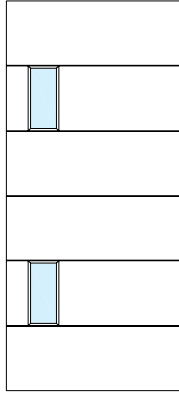

8423 F

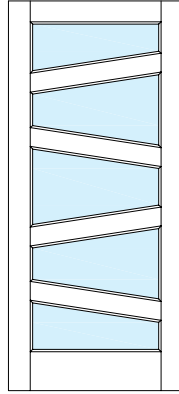

8424

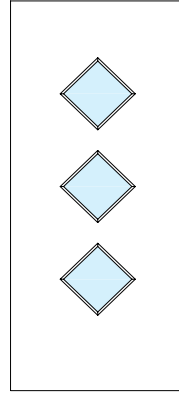

8425 F

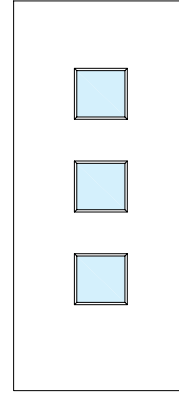

8426 F

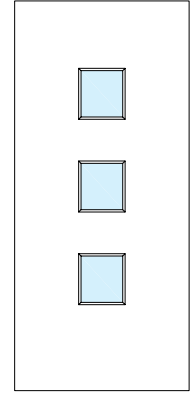

8427 F

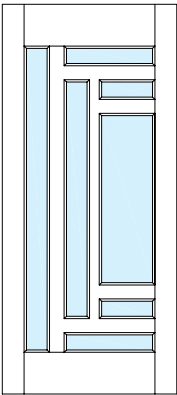

8428

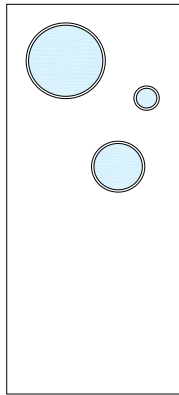

8429 F

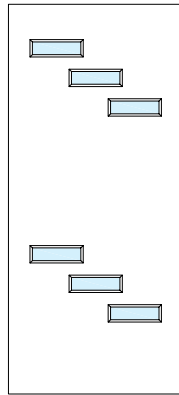

8430 F

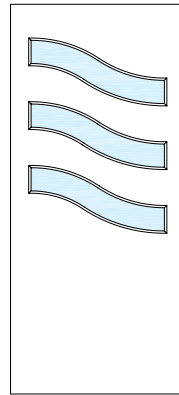

8431 F

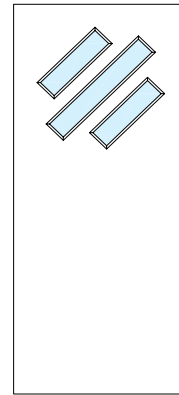

8432 F

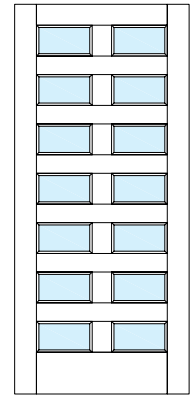

8433

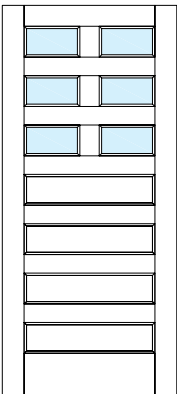

8434

F - Flush construction

Grooved and beaded panels.



Grooved and Beaded

Add craftsman style to your door with our Square Groove, V-Groove or Beaded panel option. The panels of any door that we offer can be carved with this decorative option. See the opposite page for a handful of door designs that are commonly given Square Groove, V-Groove or Beaded panels.

Note: For exterior flat panel doors, the groove or bead will stop short of the rail.

Ordering information

When specifying, Square Groove, V-Groove or Beaded Panels, use the letter "S" after the door style number for Square Groove, the letter "V" after the door style number for V-Groove panels and the letter "B" after the door style number for Beaded Panels.

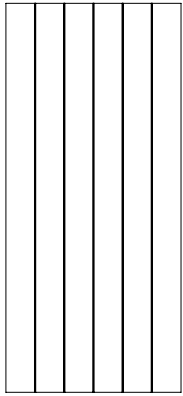

8150S/N/B *F*

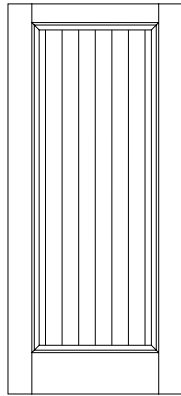

8001S/N/B

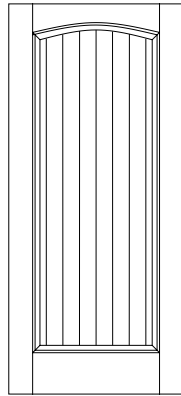

8003S/N/B

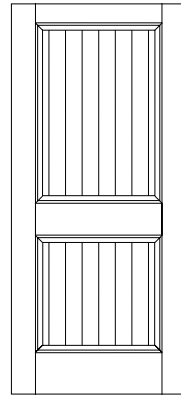

8007S/N/B

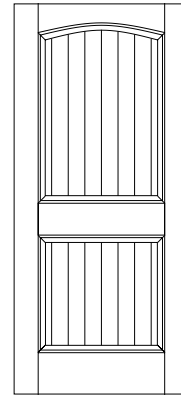

8009S/N/B

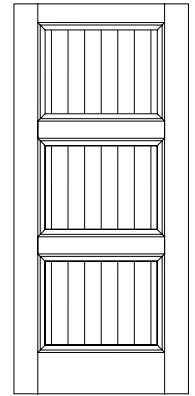

8020S/N/B

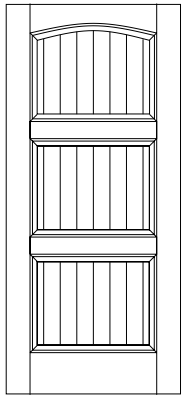

8021S/N/B

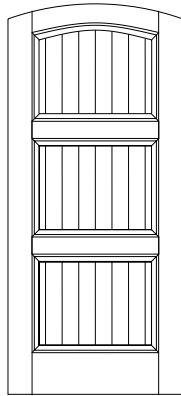

8021AS/N/B

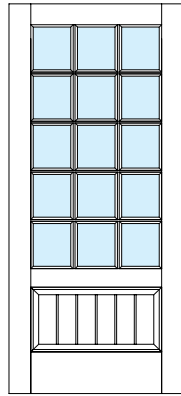

8314S/N/B

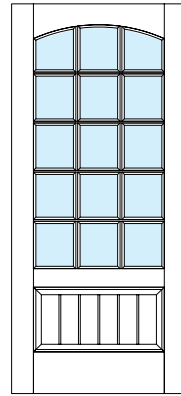

8316S/N/B

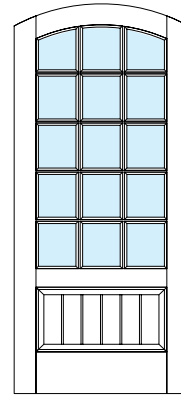

8316AS/N/B

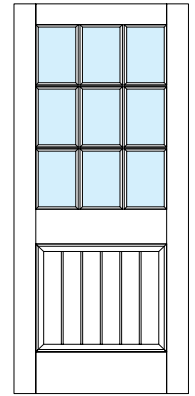

8333S/N/B

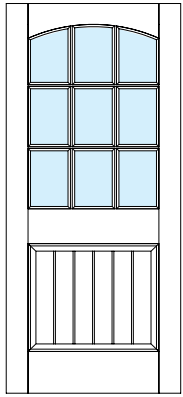

8338S/N/B

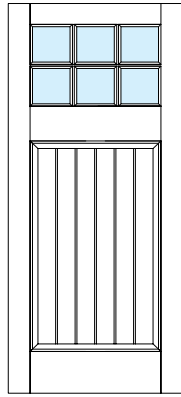

8388S/N/B

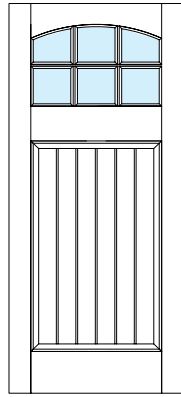

8389S/N/B

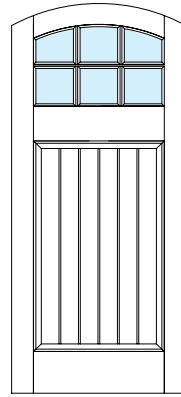

8389AS/N/B

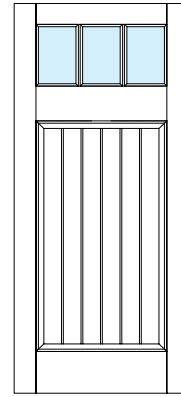

8390S/N/B

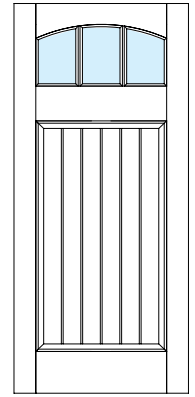

8391S/N/B

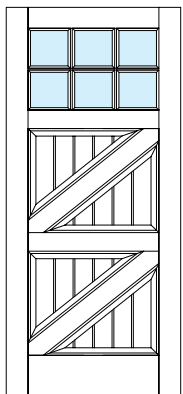

8392S/N/B

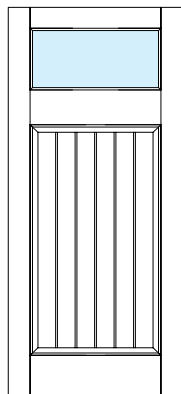

8393S/N/B

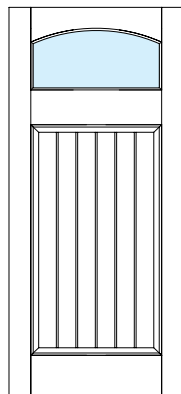

8394S/N/B

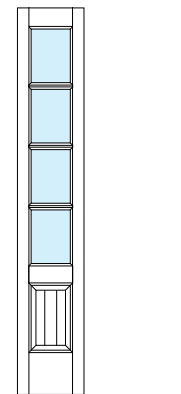

8704S/N/B

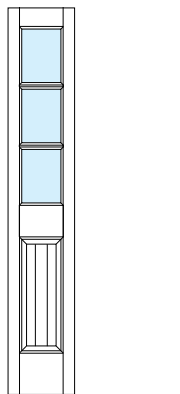

8706S/N/B

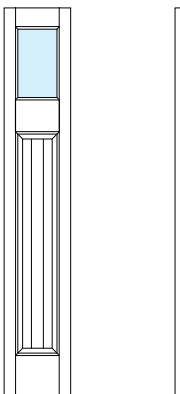

8707S/N/B

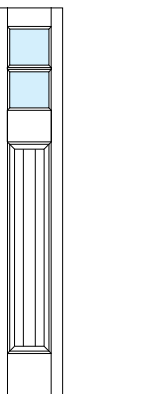

8708S/N/B

Quick Ship, see page 13

Arched Top available

F - Flush construction

Square Top available

Round Top available

Double Door Arched Pair available, see pages 38-39

Double door arched pairs.



CAPTIVA
wood doors



Custom Designed Double Door Unit, Sapele Mahogany



Custom Designed Double Door Unit

A perfectly matched pair

When creating a double door entrance unit, give it a distinctive look with a Double Door Arched Pair. Instead of simply putting two identical doors side-by-side, Double Door Arched Pairs complement each other beautifully and add architectural interest to your home.

 Look for this symbol below the door designs throughout this catalog to know which doors are available as a double door arched pair.

Panel Doors

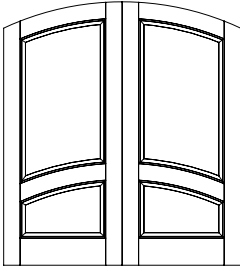

8015AP

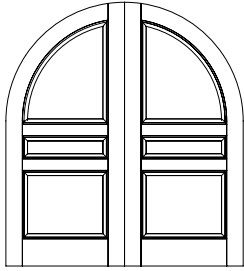

8034RP

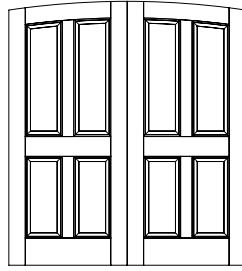

8039AP

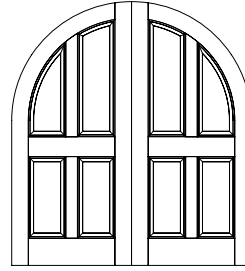

8042RP

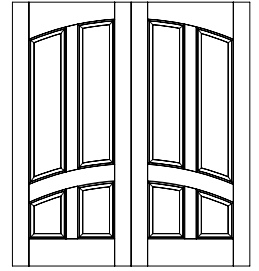

8045P

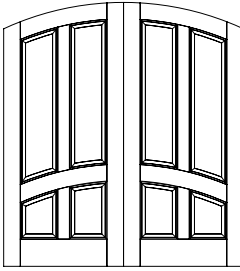

8045AP

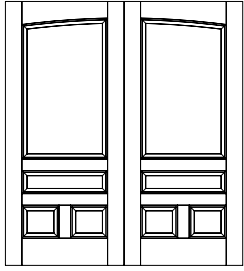

8046P

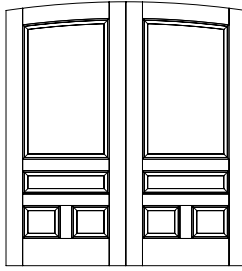

8046AP

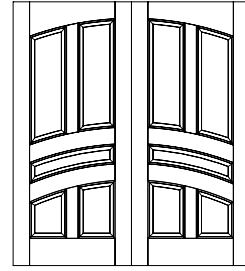

8063P

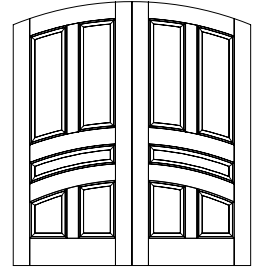

8063AP

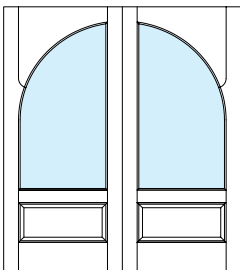

8303P

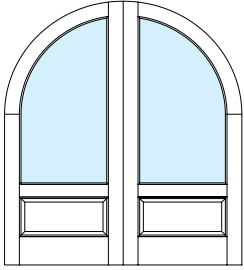

8303RP

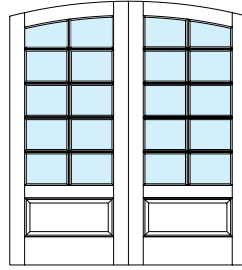

8310AP

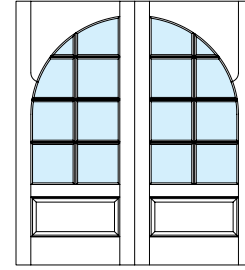

8309P

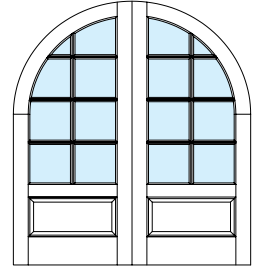

8309RP

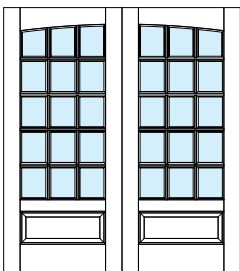

8316P

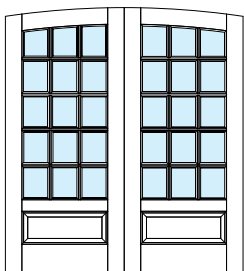

8316AP

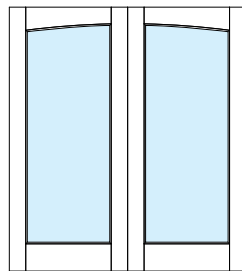

8603P

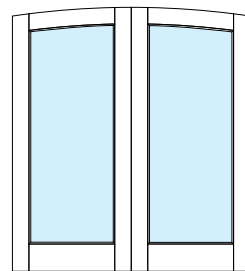

8603AP

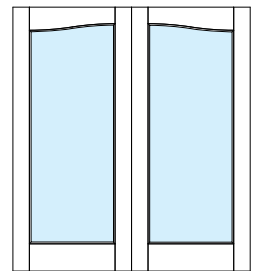

8604P

Glass Doors

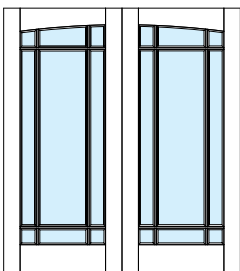

8616P

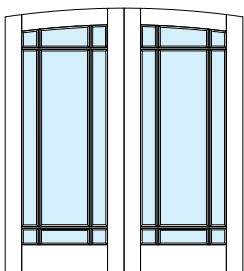

8616AP

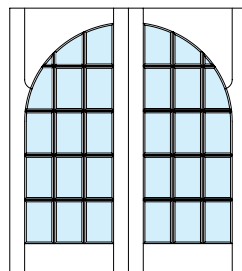

8640P

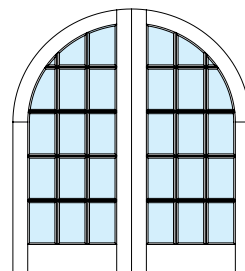

8640RP

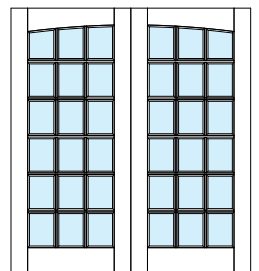

8641P

P = Pair AP = Arched Pair RP = Round Pair



CAPTIVA
wood doors



8107 Door, Reclaimed Pine with Flat Track Leatherneck Hardware
photo by Leatherneck Hardware

Barn doors.

Sliding Doors and Hardware

The only rule for Barn Doors is there are no rules; cover the hardware with trim or show it off, mix a reclaimed wood door with modern stainless steel hardware—there are so many design combinations to fit your style and décor.

Please note the following page shows traditional barn door styles; nearly every Captiva door panel in this catalog can be modified for a sliding application.



Cross-buck Detail (exterior side)

We inlay the cross-buck panels on the exterior side, creating a stronger bond and making them more resistant to water damage.

The following designs are only available in Square Groove. See page 36 for detailed image. Stile and rail construction unless otherwise noted as Flush (F). All styles below available as sliding (barn) or swinging use.

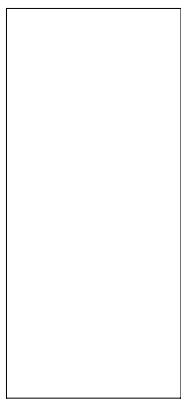

8096 F

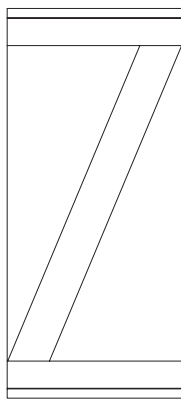

8099 F

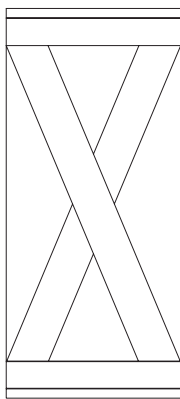

8100 F

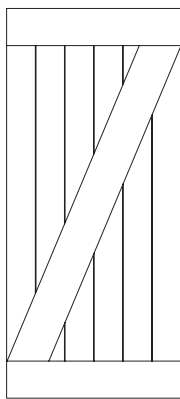

8101 F

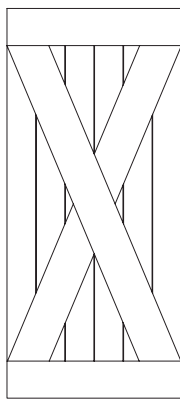

8102 F

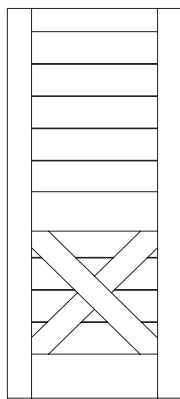

8103

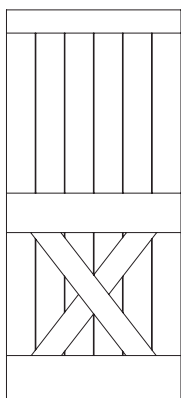

8104 F

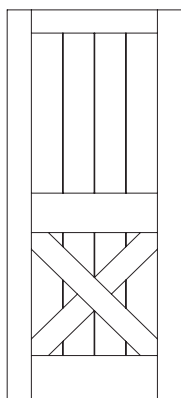

8105

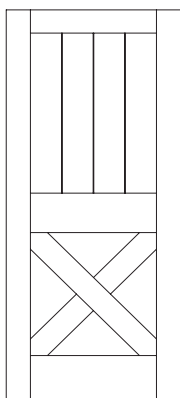

8106

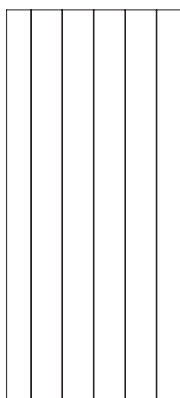

8107 F

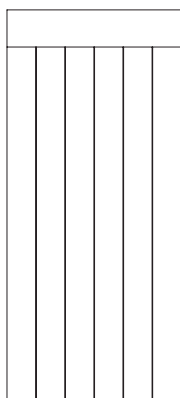

8108 F

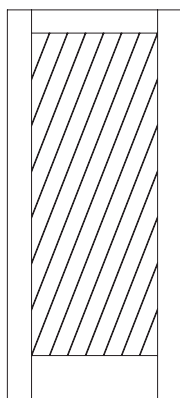

8109

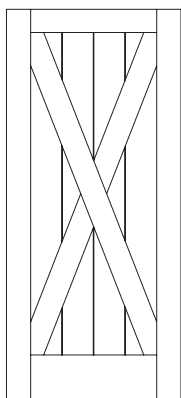

8110

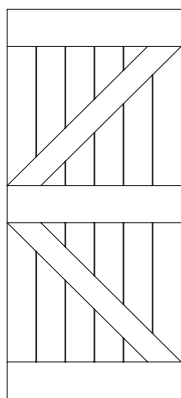

8111 F

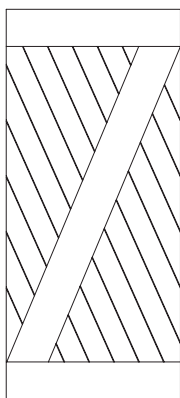

8112 F



8113 F

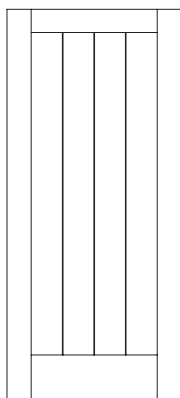

8114

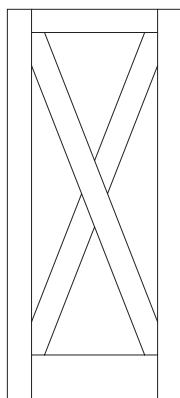

8115

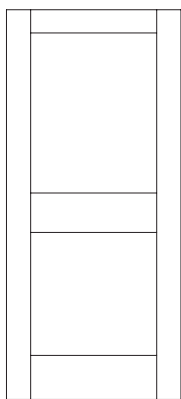

8116

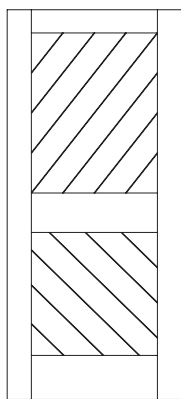

8117

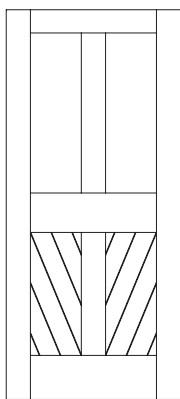

8118

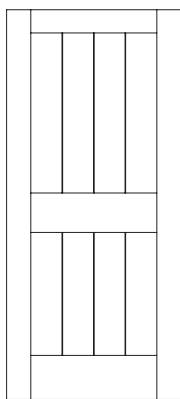

8119

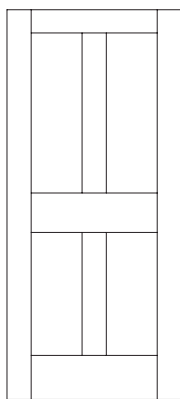

8120

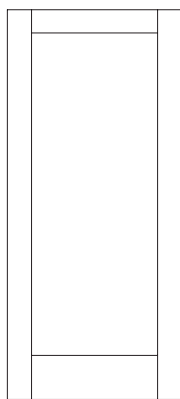

8121

F - Flush construction

Barn door hardware.



Flat Track Hardware,
Powder Coated Black

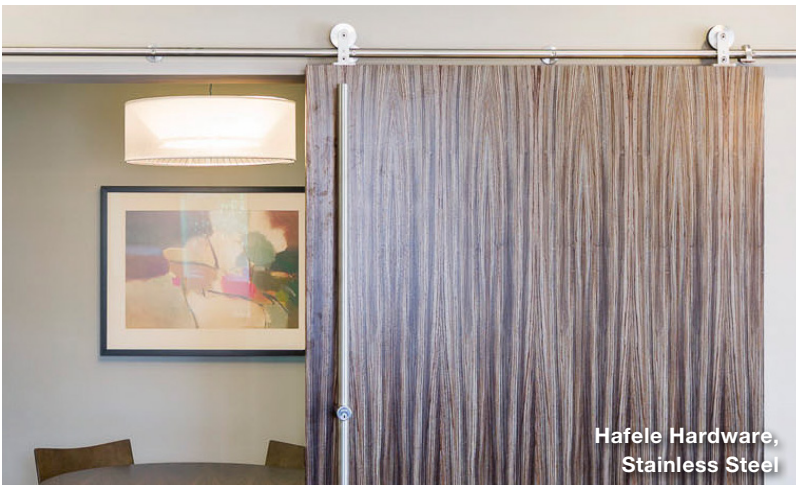

Hafele Hardware,
Stainless Steel



Pemko Hardware,
Stainless Steel

FLAT TRACK HARDWARE

FLAT TRACK BY LEATHERNECK

Flat Track Hardware styling dates back to the turn of the century when it was used in warehouses and in industrial settings. Today the highly stylized look is perfect for unique interior and exterior applications. Flat Track Hardware can be customized for specific applications and can save space while enhancing any door opening.

HÄFELE

HAFELE HARDWARE

Modern stainless steel barn door hardware available for wood barn doors or glass barn doors.



ACME HARDWARE

Acme offers 3 strap hardware styles for barn doors in Stainless Steel, Matt Black and Bronze finishes.



PEMKO HARDWARE

Pemko offers a vast array of sliding door hardware options for many commercial applications.



Dutch doors.

CAPTIVA DUTCH DOORS ARE BOTH FUNCTIONAL AND BEAUTIFUL. THEY CAN KEEP CHILDREN AND PETS SAFELY ENCLOSED WHILE LIGHT AND AIR CIRCULATE, AND ADD COLONIAL NEW ENGLAND CHARACTER TO YOUR HOME. WE HAVE ACCESS TO A RANGE OF TRADITIONAL, RUSTIC AND CONTEMPORARY HARDWARE TO COMPLEMENT YOUR STYLE.



Custom Designed Dutch Door with 8704 Sidelites and 8754 Transom, Mahogany



8069 Dutch Door with Custom Sidelites and Transom, Prefinished White Pine



Quadrant

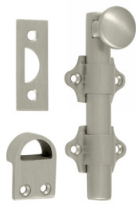

Door Bolt

Hardware

Quadrants or door bolts can be used to fasten both the lower and upper leaves of any Dutch door. They are available in a variety of finishes: including black, brass, antique brass, oil rubbed bronze, polished or brushed chrome, satin nickel, and more, to match your handleset and hinges.

Sidelites and transoms.



CAPTIVA
wood doors

THE ADDITION OF SIDELITES AND TRANSOMS GREATLY ENHANCES THE BEAUTY OF THE ENTRANCE ALLOWING NATURAL LIGHT INTO THE HOME AND A GREATER VIEW TO THE OUTSIDE. IN INTERIOR APPLICATIONS TRANSOMS ARE OFTEN USED WITH FRENCH DOORS BETWEEN THE LIVING AND DINING ROOM, PROVIDING ADDITIONAL NATURAL LIGHT AND A SOPHISTICATED LOOK.



Modified 8043 Door with Custom Sidelites and Transom, Sapele Mahogany



8307 Door with 8756 Transom, Sapele Mahogany

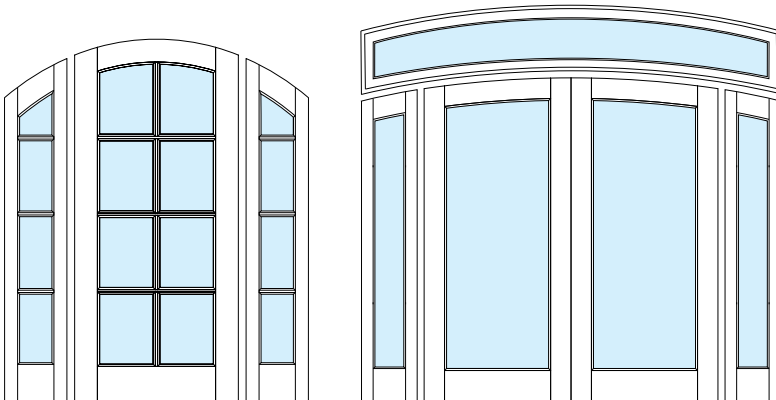

Arch Top Sidelites and Transoms

For a truly unique look, Round or Arched top shapes can often bring new life to an entryway.

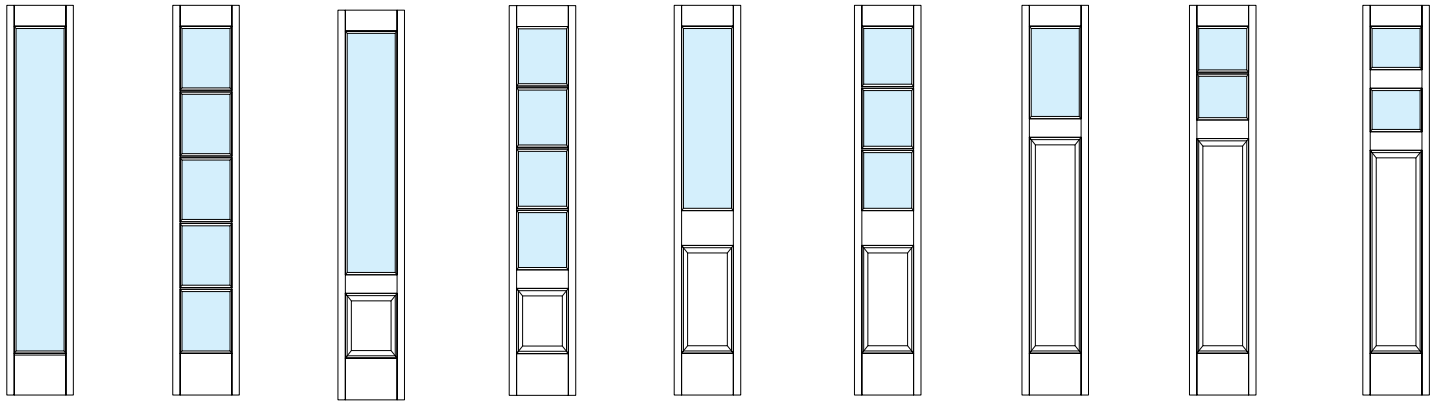

8701 8702 8703 8704 8705 8706 8707 8708 8709

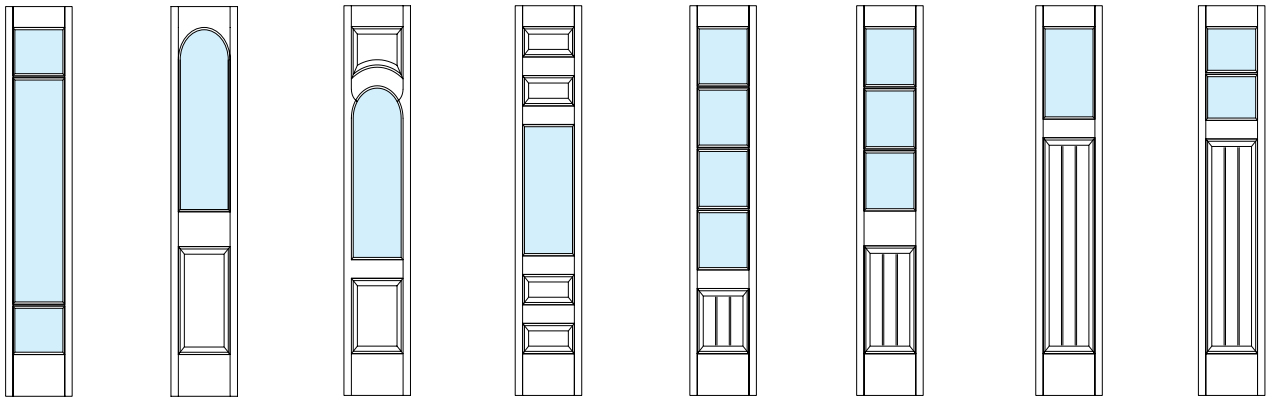

8710 8711 8712 8713 8704V/B 8706V/B 8707V/B 8708V/B

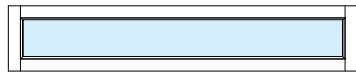

8751 Rectangular

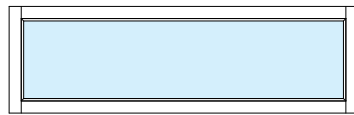

8751 Rectangular

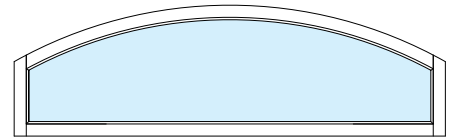

8753 Shoulder



8754 Rectangular
Specify grille pattern

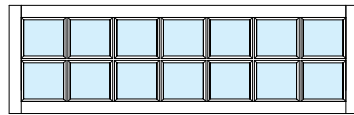

8755 Rectangular
Specify grille pattern

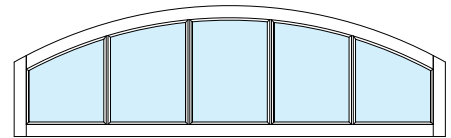

8756 Shoulder
*Specify grille pattern**

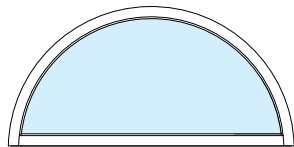

8757 Half Round

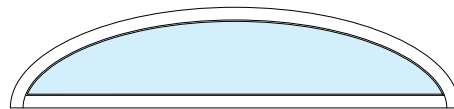

8758 Elliptical

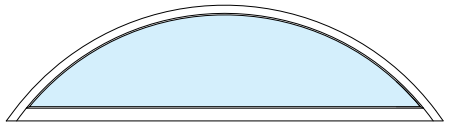

8759 Arch

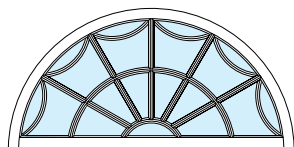

8760 Half Round
*Specify grille pattern**

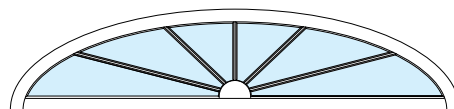

8761 Elliptical
*Specify grille pattern**

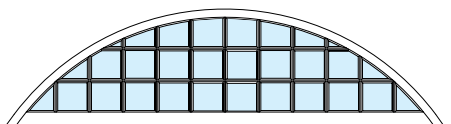

8762 Arch
*Specify grille pattern**

Note: Transoms are available in True Divided Lite and Simulated Divided Lite.

*Arch and round top transoms not available with SDL internal spacer.

Wood fire-rated doors and frames.



Modified 8078 Door, Sapele Mahogany

Captiva Fire-Rated Doors

When it comes to fire code requirements, you don't need to sacrifice the beauty and quality for safety. Our fire-rated doors are available with 20, 45, 60 and 90 minute ratings (some restrictions apply).

- 1-3/4" and 2-1/4" door thickness available
- 20, 45, 60 and 90 minute door and jamb ratings
- Flat or rabbeted jambs
- Metal jambs available for all ratings
- All fire doors and jambs available stain grade, paint grade or prefinished
- Available with flat or raised panels
- All standard sticking and panel profile designs available (see pages 14-15)
- Certified through Intertek Testing Service
- Warnock Hersey label (WH-ETL)
- Available with standard or custom hardware preps. (Some restrictions apply, e.g. concealed vertical rods not available in 90 min; concealed door closers not available in 45, 60 or 90 minute.)

Rating	Maximum Door Size	Minimum Dimension Requirements			
		Door Thickness	Stile	Top Rail	Bottom Rail
20-Minute	4/0 x 8/0 Single	1-3/4"	4-1/4"	4-1/4"	6"
	7/0 x 8/0 Pair				
45-Minute	4/0 x 8/0 Single	1-3/4"	4-1/4"	4-1/4"	6"
	7/0 x 8/0 Pair				
60-Minute	4/0 x 8/0 Single	1-3/4"	4-1/4"	4-1/4"	8-1/4"
	7/0 x 8/0 Pair				
90-Minute	4/0 x 8/0 Single	1-3/4"	5"	5"	8-1/4"

Fire door specifications.



Captiva Fire-Rated Door Technical Specs

Overview

- Fire Doors are built with FyreWerks core
- Construction process certified by Intertek Testing Service
- Applicable standards:
 - ASTM E-152-81a, UL10(c)(1998), UBC 7-2(1997), UL10(b)(1997)
 - NFPA 252(1999), ASTM E-2074(2000), CAN/ULC S104 1980 (R1985)

Fire Door Categories Available

- Category A:
 - FyreEdge concealed in edge of door
 - No added edge-sealing system required
 - Doors may have Smoke & Draft Control assemblies
- Category B:
 - No FyreEdge in edge of door
 - Requires Category “G” edge-sealing gasketing system
 - Double doors: Requires Category “G” gasket at meeting stiles
 - Doors may have Smoke & Draft Control assemblies

NOTE: Double doors require FyreEdge on meeting stiles for both Category “A” & “B”

Fire Rated Glass Guidelines (some restrictions apply)

For 60 and 90 minute, glass must be in a metal frame.

Glass Size Guidelines	
Rating	Maximum Sq. In.
20 min	1296
45 min	1296
60 min	100
90 min	100

Glass must not be within 5" of edge or opening (bore) or be in a panel

Fire-Rated Wood Jamb	
Rating	Maximum Jamb Size
20 min	4/0 x 8/0 Single
	8/0 x 8/0 Pair
45 min	4/0 x 8/0 Single
60 min	4/0 x 8/0 Single
90 min	4/0 x 8/0 Single

Metal jambs are also available for all single door applications and double door applications up to 60-minute.



Cross section of
20 Minute Fire Rated Door
with FyreWerks Core



Cross section of
45-60-90 Minute Fire Rated
Door with FyreWerks Core

Screen, storm and combination doors.

UNLIKE MODERN ALUMINUM OR VINYL STORM DOORS THAT DETRACT FROM THE STYLE OF THE HOUSE, CAPTIVA SCREEN, STORM, AND COMBINATION DOORS ARE DISTINCTIVE, YET SUBTLE, COMPLEMENTING THE EXISTING DOOR OR ARCHITECTURE. THESE DOORS ARE A GREAT WAY OF OPENING YOUR HOME UP TO THE OUTDOORS. NOT ONLY DO THEY ADD DECORATIVE FLAIR TO YOUR ENTRY WAY, BUT THEY ALSO PROTECT THE ENTRY DOOR AND KEEP BUGS OUT IN THE SUMMER WHILE ALLOWING FRESH AIR IN.



8802 Combination Door with 8701 Sidelites and 8758 Transom, Primed

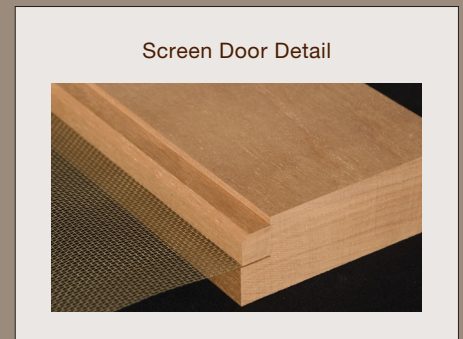

Screen Door Detail

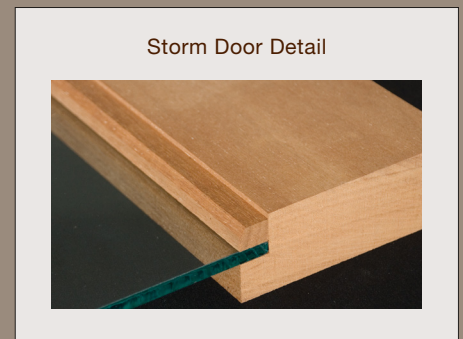

Storm Door Detail



Captiva Select Combination Door

Door Thickness Options:

Screen and Storm Doors: 1-3/4", 1-3/8", 1-1/8"

Combination Doors: 1-3/4", 1-3/8"

Prehanging: Available for Screen, Storm, and Combination doors.

Screen Choices:

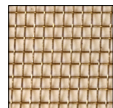

Bronze

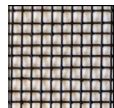

Aluminum
Charcoal

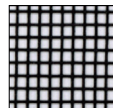

Fiberglass
Charcoal

Combination Door Hardware:

Low profile combination door hardware makes it easy for you to switch between screen and glass inserts.

Veneers: 1/8"

Warranty: 1 Year *no warranty on 1-1/8" doors



Combination Door Detail

Captiva Select

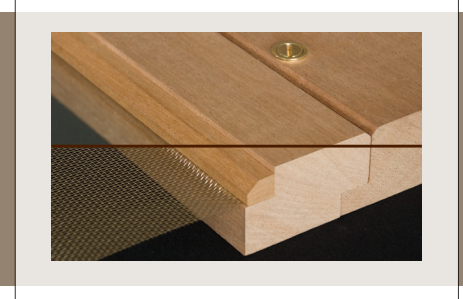

Captiva Traditional

Screen,
Storm and
Combination Doors.

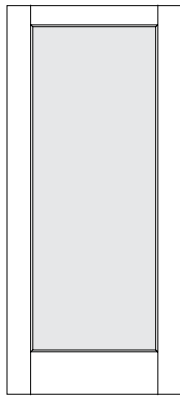

8801

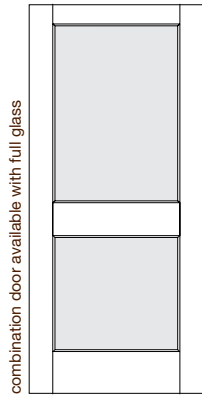

combination door available with full glass

8802

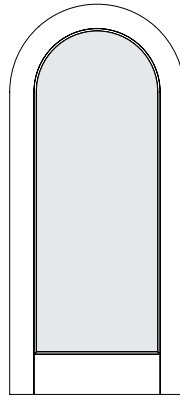

8803R S ☐

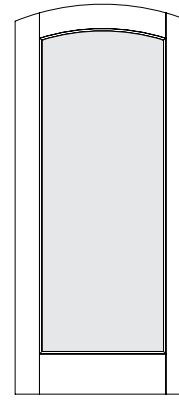

8804A S ☐

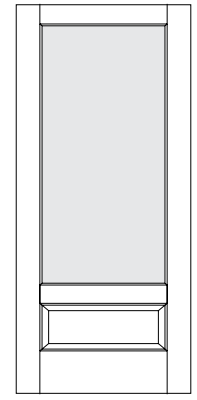

8805

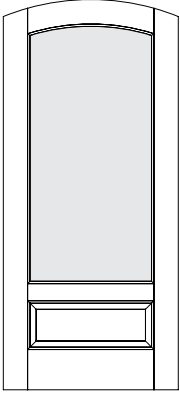

8806A S ☐

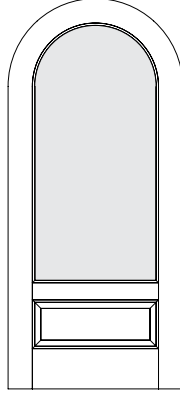

8807R S ☐

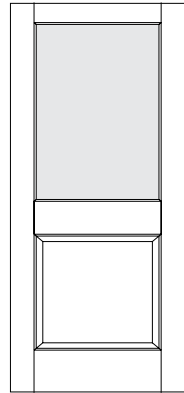

8808

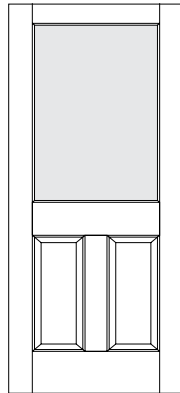

8809

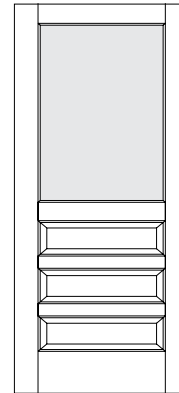

8810

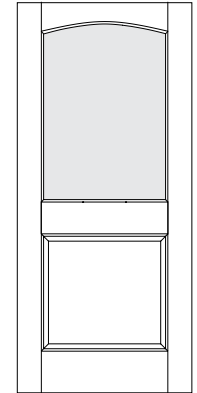

8811 A ☐

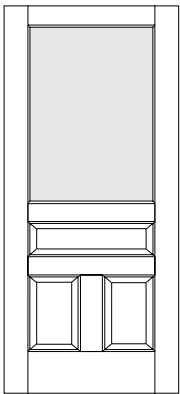

8812

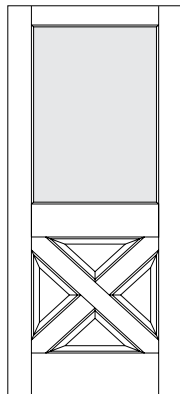

8813

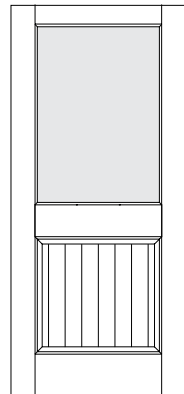

8814V/B

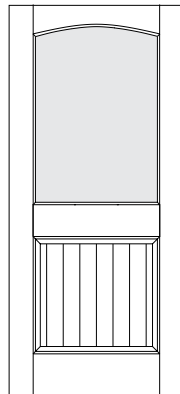

8815V/B A ☐

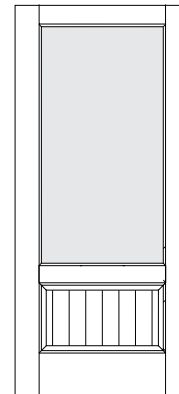

8816V/B

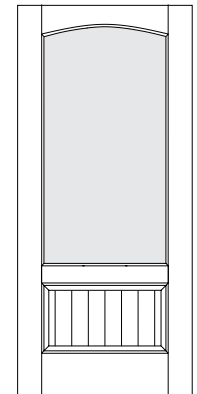

8817V/B A ☐

Screen Doors only.

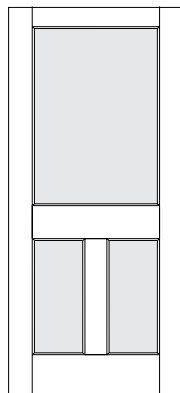

8818

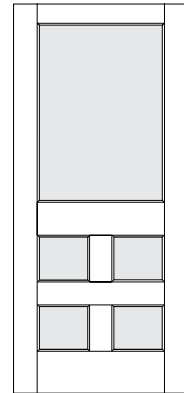

8819

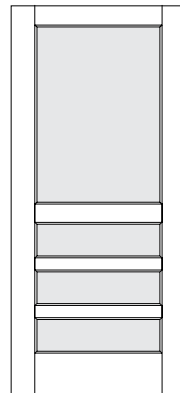

8820

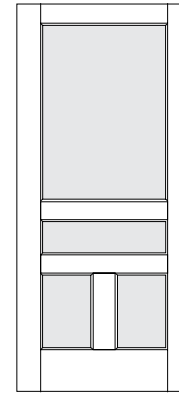

8821

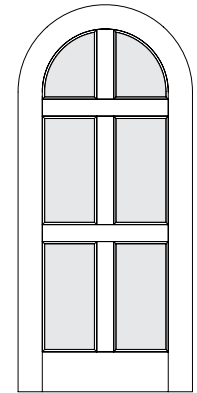

8822R S ☐

See hardware options on page 50.

Quick Ship, see page 13

A Arched Top available

S Square Top available

R Round Top available

☐ Double Door Arched Pair available, see pages 38-39

Storm and screen door hardware.

COMPLETE YOUR COMBINATION DOOR WITH THE APPROPRIATE HEAVY DUTY HARDWARE. OUR SUPPLIERS OFFER A VARIETY OF FINISHES TO COMPLEMENT YOUR STYLE. POPULAR FINISHES ARE BLACK, OIL RUBBED BRONZE, SATIN NICKEL AND CHROME.



Deltana Storm/Screen Handleset (Exterior Knob/ Interior Lever), Arched Plate, Satin Nickel



A'Dor Exterior Knob, Rectangular Plate, Oil Rubbed Bronze



A'Dor Interior Lever, Curved Plate, Satin Nickel



Heavy Duty Storm/Screen Door Closer (Available in Single or Double Cylinder)

Hardware	Available Finishes
Deltana Handlesets	Polished Brass, Antique Brass, Oil Rubbed Bronze, Brushed Nickel, Antique Nickel, Paint Black, Polished Chrome, Brush Chrome PVD Brass
A'Dor Handlesets	Bright Brass (lacquered or not lacquered), Satin Nickel, Oil Rubbed Bronze, Aged Bronze
Closers	White, Almond, Sandstone, Black, Bronze
Wind Chains	Black, White, Stainless Steel

Retractable screens.

CUSTOM DESIGN DOOR SCREENS OFFER THE BEST OF BOTH WORLDS - UNINTERRUPTED VIEWS AND NATURAL VENTILATION COMBINED WITH PROTECTION FROM INSECTS AND HARSH GLARE OF THE SUN. THE RETRACTABLE SCREEN REMAINS OUT OF SIGHT UNTIL YOU NEED IT, SO YOU CAN SHOW OFF YOUR BEAUTIFUL CAPTIVA DOOR ALL YEAR LONG.



Screen housing concealed in door frame

With our custom millwork capabilities we can preinstall a retractable screen on your Captiva door unit prior to shipping. You can choose a basic surface application or for the ultimate smooth look, a Phantom screen can be concealed in the doorframe. It doesn't matter if your Captiva door is an inswing or outswing, single, French, sidelite or Dutch door unit, there is a screen solution for each.

Concealed screen option adds to the unit width and requires special components. Please ask our Captiva specialist for more information on this option.

Captiva Wood Doors uses Phantom® Retractable Screens.



CAPTIVA
wood doors

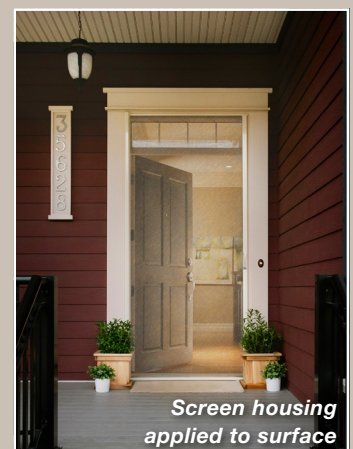

Screen housing applied to surface

PHANTOM®
SCREENS

Not knowing when the dawn will come I open every door.
- Emily Dickinson



Modified 8417 Double Door Unit, Sapele Mahogany



Modified 8028 Door with 8701 Sidelites
and Custom Transom, Fir



Modified 8408 Door, Walnut



Custom Designed Flush Door, Red Oak

Custom designs.



CAPTIVA
wood doors

BECAUSE EVERY DOOR THAT WE MANUFACTURE IS MADE SPECIFICALLY FOR YOU, HERE'S YOUR CHANCE TO BE CREATIVE... CHOOSE SAPELE STILES AND RAILS WITH MAPLE PANELS... OR TURN ONE OF OUR STANDARD PANEL DOORS INTO A GLASS DOOR BY SWAPPING THE WOOD PANELS WITH GLASS. THE SKY'S THE LIMIT SO ALLOW YOUR CREATIVE JUICES TO FLOW!



8020 Door, Cherry Stiles and Rails, Maple Panels

Mix 'n Match Species

Pick a standard door and create a custom look. There's no reason why the species of wood used for the stiles and rails of a door need to match the panels. In the example above, the builder chose our 8020 panel door with cherry stiles and rails and maple panels.



Modified 8069 Door (Glass Inserts) with 8760 Transom

Swap Panels and Glass

While browsing our door designs, keep in mind that any panel can be replaced with glass. In the example above, the homeowner chose a pair of 8069 panel doors and replaced the top four panels on each door with insulated glass.



Design your own door.



Custom Designed Doors

In addition to the door designs shown throughout this catalog, with Captiva the possibilities are endless. Simply provide us with a drawing, photograph, or sketch and we will custom design and build the door of your dreams. This is a perfect solution for historical replication or signature projects.

Door comparison chart.

	Captiva Select Doors	Captiva Traditional Doors
STILES		
Construction		
Stave core with 1/8" veneer	●	○
Stave core with 1/4" veneer	○	●
Solid cap on top stiles		●
Size		
Special Widths Available	○	○
RAILS		
Construction		
Stave core with 1/8" veneer	○	○
Stave core with 1/4" veneer	○	●
Solid	●	○
Size		
Special Widths Available	○	○
PANELS		
Raised Panels		
One Solid Panel		○
Two Floating Panels	●	●
Flat Panels		
One Solid Panel	●	●
Book Match Panels (required to meet AWI premium grade with transparent finishes)	○	○
DOOR SIZES		
Maximum Width		
3'6"	●	●
Unlimited	○	○
Maximum Height		
8'0"	●	●
Unlimited	○	○
SANDING		
Assembled door is sanded with a patented CPSII segmented pad system wide belt sander. Customer required to remove cross grain.	●	●
JOINERY		
Beaded Mortise & Tenon Joints	●	
Traditional Mortise & Tenon Joints		●
DOOR DESIGNS		
Specified Door Designs	●	●
Unlimited Door Designs	○	○
DOOR SHAPES		
Specified Door Shapes	●	●
Unlimited Door Shapes	○	○
PREFINISHING		
4 mil Double Prime	○	○
4 mil Clear Coat	○	○
Fortress Coating Systems™ Stain	○	○
Fortress Coating Systems™ Paint	○	○
WARRANTY		
2 Year Warranty (10 Year Interior)	●	
5 Year Warranty (10 Year Interior)	○	●
10 Year Extended Warranty		○

● Standard

○ Optional (may void warranty in certain sizes or construction types)

Above chart does not apply to screen, storm, and combination doors.



CAPTIVA
wood doors

Jambs, casing and sills.



CAPTIVA
wood doors

JAMB

We offer single rabbet and double rabbet jambs in 4-5/8", 6-5/8" or any custom width. Available in matching specie, clear or primed pine.



Single Rabbet Jamb (Interior)
4-5/8"



Double Rabbet Jamb (Interior)
4-5/8"



Single Rabbet Jamb (Interior)
6-5/8"



Single Rabbet Jamb with Weatherstrip 6-5/8" (Exterior)



Primed FrameSaver® Jamb with Weatherstrip, up to 9-1/8" (Exterior)



Primed 20-minute Fire Door Jamb 4-5/8" to 9-1/4" (Exterior)

CASING

Available in clear or primed pine, or matching species. All patterns and thicknesses are available for exterior or interior use. Below are just three of the most common profiles, ask your sales rep to see our full library of hundreds of casing options. Custom casing is available in any design, species or size.



Brickmould Casing
1-1/8" x 1-7/8"



Flat Casing
1" x 3-1/2"



Custom Casing (N1932)
1-5/8" x 3-1/2"

Custom casings are available in any design, species or size.

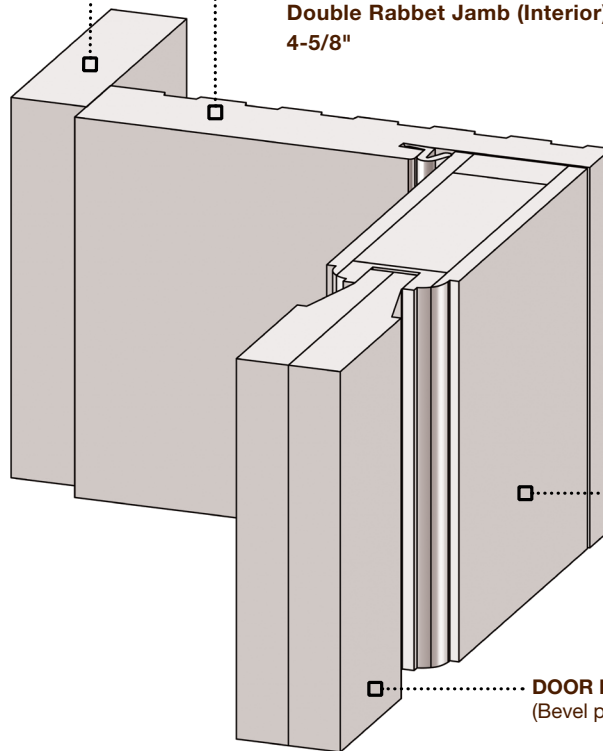

DOOR STILE

(Ovolo sticking shown, see page 15)

DOOR PANEL

(Bevel profile shown, see page 14)

MAHOGANY SILLS



Inswing Sill (Oak or Sapele Mahogany)
1-11/16" x 9-1/4"



Outswing Nantucket Sill (Sapele Mahogany)
1-5/8" x 7-1/4"



Inswing Nantucket Sill (Sapele Mahogany)
2-1/8" x 9"



Outswing Nantucket Sill (Sapele Mahogany)
1-5/8" x 9-1/4"

COMPOSITE SILLS: ENDURA Z SERIES

Z-AC Articulating Cap Sill

The Z-AC automatically self-compensates to create the perfect door seal under any conditions. The Z-AC helps overcome most problems associated with either inconsistency of the rough opening or margins between the sill and the door. Can only be used with 1-3/4" door thickness and non-standard specialized sweep.

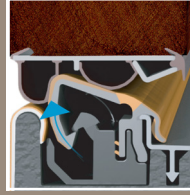

Cap rises to engage door bottom



Bronze

Bumper Outswing Sill

The ultimate protection in high exposure areas and severe weather conditions. The seal increases with pressure against the door, creating a tough seal against air and water infiltration. Available in Mill or Bronze finish.



Mill

Z Classic Sill

The Z-Lineal Sill features the classic version of a full continuous extruded substrate for ultimate flexibility and custom fabrication. Can only be used with 1-3/4" door thickness. Length up to 3'0" (single door) or 6'0" (double door). Available in Mill or Bronze finish.



8301 Door with 8703 Sidelites, Sapele Mahogany

PEMKO SWEEP OPTIONS

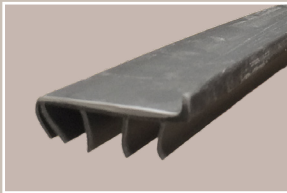

STANDARD: FIVE FIN SWEEP

For 1-3/4" and 2-1/4" doors

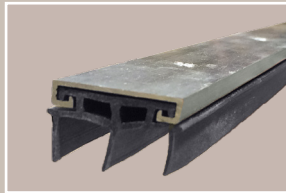

2343AV SWEEP

For 1-3/4" and 2-1/4" doors

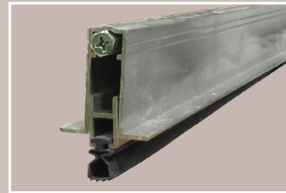

411 AUTOMATIC SWEEP

For 1-3/4" and 2-1/4" doors (for single doors only)

PEMKO ADA SILL THERMAL BREAK

ADA Compliant Sills incorporate a dam that meets ADA height requirements and creates a better seal between the door and sill. A thermal sill will prevent heat or cold temperatures from transferring from the outside of the house to the inside of the house.



Sills available from 4" to 12"

ALUMINUM ADA SILLS

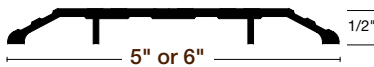

AT600 & 601 (HANDICAP)

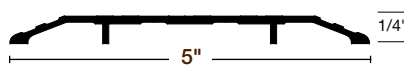

AT500 (HANDICAP)

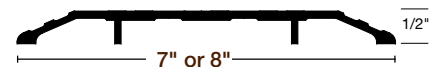

AT701 & 801 (HANDICAP)

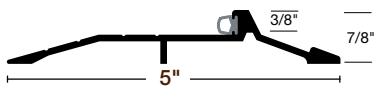

AT599 (OUTSWING)

Hardware.



ACCESS CONTROL AT ALL ENTRANCES AND EXITS TO A HOME OR BUILDING IS AN IMPORTANT PART OF THE DOOR SYSTEM. IN RESIDENTIAL SETTINGS, A HOMEOWNER'S NUMBER ONE CONCERN IS SECURITY, BUT THEY ARE ALSO LOOKING FOR HARDWARE THAT IS DECORATIVE, COMPLEMENTING THE DOOR AND STYLE OF THEIR DÉCOR. YEARS AGO THERE WAS NOT NEARLY THE SELECTION OF HARDWARE THAT THERE IS AVAILABLE TODAY.



Residential Handle Set, Bronze



Folding Door Hardware, Brass

Exterior Handle Sets

A handle set provides security while the styles and finishes complement the door. We offer a wide array of residential hardware available from Rocky Mountain, Baldwin, Emtek, Ashley Norton, Schlage and many other high quality suppliers.

Interior Hardware

Interior door hardware enhances your interior doors with hundreds of design and finish combinations to choose from. We offer interior door hardware from Rocky Mountain, Baldwin, Emtek, Ashley Norton, Schlage and many other high quality suppliers.

Hinges

We offer a wide selection of hinges including 3-1/2", 4-1/2" and 5" in plain bearing and ball bearing, in a whole array of finishes to ensure that your door both functions perfectly and is aesthetically coordinated.



I've got the key to my castle in the air,
but whether I can unlock the door remains to be seen.



– Louisa May Alcott, *Little Women*



**Multi-Point Hardware
with Handle Set, Bronze**



**Commercial Hardware (Exit Device and Door Closer),
Bright Brass**



**Large Selection
of Hinges**

Multi-Point Hardware

Multi-Point hardware systems from Trilennium provide more than just security, they offer homeowners better door closure and sealing than single point locks. The locking mechanism features a durable and ergonomic design, allowing for easy door operation. It also meets or exceeds the most stringent hurricane codes (Exceeds ASTM Grade 40 & DP95).

Commercial Hardware

We have an extensive inventory of Residential and Commercial hardware in stock available for your use with our Captiva doors. For commercial applications we can pre-machine our doors for your hardware or we can supply new hardware from one of our many lines available - Cylindrical or Mortise locks from manufacturers such as Schlage, Sargent, Corbin, Omnia, Ashley Norton or Baldwin; Exit devices from Von Duprin, Sargent, Precision and many others. Access control and electronic hardware are also available when required.

Popular hardware designs.

Following is a small sample of door hardware from our suppliers. Popular finishes are Black, Oil Rubbed Bronze, Satin Nickel and Chrome.

Rocky Mountain



Flute Pull



Flute Leverset



Flute Knobset



Convex Knobset



Convex Leverset



Corbel Knobset

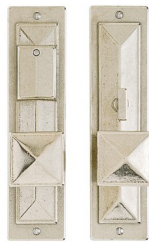

Mack Knobset

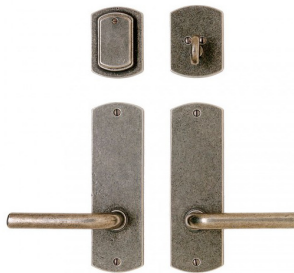

Curved Leverset



Paris Entryset



Paris Passage Set

Baldwin



Atlanta Entryset



Chicago Entryset



Denver Entryset



Baltimore Entryset



Barclay Entryset



Bristol Entryset



Hamilton Entryset



Lancaster Entryset



Pasadena Entryset



Egg Knob



5064 Knob



Filmore Knob



5069 Knob

Emtek



Lausanne



Davos



Zeus



Arts & Crafts



Stuttgart Lever

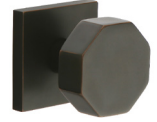

Octagon Knob



Helios Lever



Round Knob



Adams



Wilshire



Melrose



Wilmington



Merrimack Lever



Egg Knob



Cortina Lever



Norwich Knob

Keyless entry and electronic hardware.



Baldwin



Emtek



Kwikset KEVO

KEVO Bluetooth-Enabled Electronic Deadbolt unlocks with a touch.



Multi-point locking system.

OPERATING AS ONE, ALL THREE OF THE TRILENNIUM® MULTI-POINT LOCKING SYSTEM'S LATCHES ENGAGE WHEN THE DOOR IS CLOSED, ACTIVATING WITH JUST ONE MOVEMENT OF THE KEY OR THUMBTURN, AND RELEASING WITH A SINGLE DOWNWARD TURN OF THE INTERIOR HANDLE. WHEN ACTIVATED, EACH LATCH BECOMES A DEADBOLT THAT CAN'T BE COMPROMISED, OFFERING INCREASED SECURITY, HIGHER PERFORMANCE AND PEACE OF MIND.

ROCKY MOUNTAIN
H A R D W A R E

Rocky Mountain Hardware For Multi-Point Locks



EMTEK
ASSA ABLOY

Emtek Hardware For Multi-Point Locks

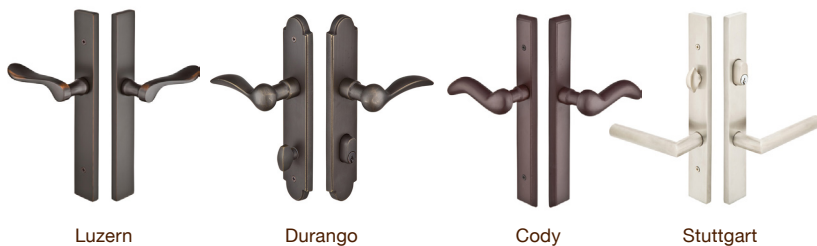

T TRILENNIUM®
MULTI-POINT LOCKING SYSTEMS

Trilennium Hardware For Multi-Point Locks



For more information on the Trilennium Multi-Point Locking System, visit www.enduraproducts.com.

This is a small sample of the multi-point hardware styles that are available.



Commercial capabilities.

CAPTIVA WOOD DOORS ARE NOT ONLY INSTALLED IN HOMES, BUT ALSO IN COMMERCIAL BUILDINGS THROUGHOUT NEW ENGLAND: RESTAURANTS, HOTELS, SCHOOLS, OFFICE BUILDINGS, HOSPITALS, BANKS, GOVERNMENT BUILDINGS AND COUNTRY CLUBS. CAPTIVA WOOD DOORS ARE BUILT FOR QUALITY AND ENDURANCE TO ENSURE THEY WILL TOLERATE DAILY WEAR AND TEAR OF PUBLIC USE. WE HAVE THE EXPERTISE AND EXPERIENCE IN WORKING WITH ALL PARTIES INVOLVED IN THE CONSTRUCTION PROCESS AND CAN SUPPLY THE PROPER HARDWARE TO USE FOR COMMERCIAL APPLICATIONS.



Modified 8601 Double Door Unit, Sapele Mahogany



8601 Door with 8701 Sidelites, 5751 Transom and Custom Ceiling Panel, Sapele Mahogany



Custom Double Door Unit with Custom Transom, Sapele Mahogany



8321 Door, Sapele Mahogany



8627 Double Door Unit, Sapele Mahogany

Prefinishing.

SAVE TIME AND JOB SITE LABOR COSTS BY HAVING US PREFINISH YOUR CAPTIVA DOORS. WE OFFER STATE-OF-THE-ART FORTRESS COATING SYSTEMS™ PREFINISHING ON ALL OUR DOORS. CHOOSE A SUPERIOR PRIMED OR CLEAR COAT FINISH, STAIN, OR ONE OF OUR SHERWIN WILLIAMS PAINT COLORS. WE OFFER 4 STOCK STAIN COLORS, 10 STOCK PAINT COLORS, 40 CUSTOM PAINT COLORS, OR YOU CAN CHOOSE ANY SHERWIN WILLIAMS COLOR NUMBER.

Option 1: Clear Coat

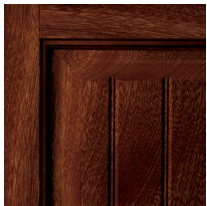

4 mil Clear Coat

Our durable 4 mil Ilva clear coat offers UV protection and saves time on the job site with a three step finish process (impregnator and two top coats) with multiple sand and preparation steps.

(See page 66 for use and care)

Option 2: Primed



4 mil Double Prime

For doors that are intended to be painted, let us save you a step. We double prime doors with a high quality primer.

Option 3: Stain

Ilva water-based wood coatings are specially formulated for coating and protecting exterior wood doors. ILVA, based in Italy, is the foremost name in the world when it comes to the research, development and manufacture of high-quality wood coatings. Stain will not crack, flake, chalk, blister or lift from wood substrates and will protect wood from mold, UV rays, water and pollutants. Fortress Coating Systems™ offers 4 stock colors of Ilva Klima® stain.

		STOCK STAIN COLORS				
		Clear	Fir	Teak	Dark Walnut	Mahogany
WOOD SPECIES	Sapele Mahogany					
	White Oak					
	Fir					

Due to variations that may occur in the printing process of this catalog, as well as how stain colors vary on different wood species, these swatches are an approximate color match. Please see your sales representative for actual stain samples on the species of wood you select.



Maintain your finish with Klima's Aquatech Retoning Liquid (TN030), available upon request.



Option 4: Paint

Fortress Coating Systems™ offers 10 stock colors of Sherwin Williams paint, 40 custom colors or you can provide any Sherwin Williams number.



CAPTIVA
wood doors



ColorSnap® App for Mobile Devices

With ColorSnap from Sherwin-Williams, you have the power to take real-world colors and turn them into paint-color swatches—all on your smartphone. Create palettes, adjust hues, and store them all in one place.



Rustic Red SW 7593

STOCK PAINT COLORS

Tricorn Black SW 6258	Burgundy SW 7461	Chateau Brown SW 7510	Rustic Red SW 7593	Pure White SW 7005
Blue SW 7465	Blue/Gray SW 6243	Summit Gray SW 7669	Meridian Green SW 7463	Maison Blanche SW 7526

CUSTOM PAINT COLORS

Restful White SW 7563	Antique White SW 6119	Inviting Ivory SW 6372	Nomadic Desert SW 6107	Macadamia SW 6142	Basket Beige SW 6143	Latte SW 6108	Hopsack SW 6109
Dapper Tan SW 6144	Chamois SW 6131	Quiver Tan SW 6151	Plantation Brown SW 7520	Turkish Coffee SW 6076	Marooned SW 6020	Polished Mahogany SW 2838	Sommelier SW 7595
Zeus SW 7744	Lemon Verbena SW 7726	Messenger Bag SW 7740	Garden Gate SW 6167	Warm Stone SW 7032	Green Earth SW 7748	Secret Garden SW 6181	English Ivy SW 2935
Olympic Range SW 7750	Shade Grown SW 6188	Red Theatre SW 7584	Cordovan SW 6027	Sundried Tomato SW 2915	Royal Copper Red SW 2839	Black Emerald SW 2936	Temperstar SW 6229
Storm Cloud SW 6249	Sea Serpent SW 7615	Naval SW 6244	Dark Night SW 6237	Black Fox SW 7020	Urbane Bronze SW 7048	Iron Ore SW 7069	Yarn SW 6643

Due to variations that may occur in the printing process of this catalog, these color swatches are just an approximate color match. Please visit your local Sherwin-Williams store or visit www.sherwin-williams.com to use their color design tools.

Warranty: Captiva interior doors.



CAPTIVA
wood doors

10 YEAR WARRANTY - CAPTIVA SELECT/TRADITIONAL INTERIOR DOORS (NON-FIRE-RATED)

5 YEAR WARRANTY - CAPTIVA SELECT/TRADITIONAL INTERIOR DOORS (20/45/60/90 MINUTE FIRE-RATED)

Captiva Wood Doors warrants to the original purchaser of an interior Captiva Wood Door that the product shall be free from defects in material and workmanship. The warranty period shall commence on the date of delivery.

The warranty periods are as follows: Captiva Select/Traditional (non-fire-rated): 10 years
 Captiva Select/Traditional (20/45/60/90 minute fire-rated): 5 years

Should the product fail to conform to this warranty within the warranty period, Captiva Doors will, at its option, (i) repair the product, (ii) replace the product in its original state of purchase, or (iii) refund the price originally paid to Captiva for the product.

This Warranty Does Not Cover:

- 1) Damage caused by failure to comply with the instructions in the Captiva Door Use & Care Guide.
- 2) Any door that is over 42" in width and/or 96" in height.
- 3) Warp that does not exceed ¼" in the plane of the door itself for doors not over 36" x 84". Warp that does not exceed 3/8" in the plane of the door itself for doors over 36" x 84". *Note: Captiva may defer repairing or replacing the product for up to 12 months from the date of installation or claim, as the warp may prove temporary as the door adjusts to weather conditions. This deferral will not count against the warranty period.*
- 4) Damage caused by anyone other than a Captiva representative while attempting to repair the product.
- 5) Damage caused by improper installation.
- 6) Damage caused by trimming more than one inch total of the product.
- 7) Doors trimmed at the top, more than 1" at bottom, or more than ¼" at each side.
- 8) Damage caused by nonalignment or bow in the frame or jamb in which the door is hung.
- 9) Natural variations in color, texture, character, or grain of wood.
- 10) Variations in gloss level, texture, or appearance resulting from field finishing.
- 11) Panel shrinkage or expansion due to natural characteristics of wood movement.
- 12) Gaps in stile and rail joints of 1/16" or less.
- 13) Doors containing dual wood species of face veneers and/or planks on each side.
- 14) Damage caused by failing to seal all six sides and hardware cutouts of the door. Doors must be sealed within 72 hours of fitting and/or hanging.
- 15) Damage caused by any cause beyond the control of Captiva, including, but not limited to, normal wear and tear, weathering, customer misuse/abuse/neglect, or acts of nature.
- 16) Doors shipped out of the continental US.
- 17) Any costs or charges relating to the replacement of the product, including transportation, shipping, removal, finishing, and installation.
- 18) Damage caused by failure of glazing, if the manufacturer's warranty period for that glazing has expired.

Warranty Claims

Warranty claims must be submitted within 30 days of discovery of the believed issue. Claims must be submitted via email to techsupport@northatlanticcorp.com or in writing to Captiva Wood Doors Warranty Claims, 1255 Grand Army Hwy, Somerset, MA, 02726 and must include proof of purchase of product.

Express Limitation

This warranty sets forth Captiva's maximum liability for its products. No other warranty, expressed or implied, with respect to its product is made. Captiva's liability is limited to the refund of the purchase price or repair or replacement of the defective product. This warranty is non-transferable.

Disclosure

Formal acceptance of this warranty is not required. By accepting delivery of the product, the customer is also accepting the terms and conditions of the Captiva Doors limited warranty.



Custom Door with Beaded Panels



CAPTIVA
wood doors

Warranty: Captiva exterior doors.

2 YEAR WARRANTY - CAPTIVA SELECT DOORS*

5 YEAR WARRANTY - CAPTIVA TRADITIONAL DOORS*

Captiva Wood Doors warrants to the original purchaser of an exterior Captiva Wood Door that the product shall be free from defects in material and workmanship. The warranty period shall commence on the date of delivery.

The warranty periods are as follows: Captiva Select Series: 2 years*
 Captiva Traditional Series: 5 years*

*Extended warranty period is available. See Extended Warranty documentation for details.

Should the product fail to conform to this warranty within the warranty period, Captiva Doors will, at its option, (i) repair the product, (ii) replace the product in its original state of purchase, or (iii) refund the price originally paid to Captiva for the product.

This Warranty Does Not Cover:

- 1) Damage caused by failure to comply with the instructions in the Captiva Door Use & Care Guide.
- 2) Damage caused by failure to provide an adequate overhang to protect the door from the elements. See the Use & Care Guide for overhang requirements. Doors that are installed with multi-point locking hardware may not require overhang protection. Multi-point locking hardware will help stabilize the door and prevent warp.
- 3) Any door that is over 42" in width and/or 96" in height.
- 4) Warp that does not exceed 1/4" in the plane of the door itself for doors not over 36" x 84". Warp that does not exceed 3/8" in the plane of the door itself for doors over 36" x 84". *Note: Captiva may defer repairing or replacing the product for up to 12 months from the date of installation or claim, as the warp may prove temporary as the door adjusts to weather conditions. This deferral will not count against the warranty period.*
- 5) Damage caused by anyone other than a Captiva representative while attempting to repair the product.
- 6) Damage caused by improper installation.
- 7) Damage caused by trimming more than one inch total of the product.
- 8) Doors trimmed at the top, more than 1" at bottom, or more than 1/4" at each side.
- 9) Damage caused by nonalignment or bow in the frame or jamb in which the door is hung.
- 10) Natural variations in color, texture, character, or grain of wood.
- 11) Variations in gloss level, texture, or appearance resulting from field finishing.
- 12) Panel shrinkage or expansion due to natural characteristics of wood movement.
- 13) Gaps in stile and rail joints of 1/16" or less.
- 14) Doors containing solid wood panels wider than 14".
- 15) Doors containing dual wood species of face veneers and/or planks on each side.
- 16) Damage caused by failing to seal all six sides and hardware cutouts of the door. Doors must be sealed within 72 hours of fitting and/or hanging. The tops of all outswing doors must be flashed for weather.
- 17) Damage caused by temperature buildup where a storm door is present. Screen and storm doors are not covered under warranty.
- 18) Damage caused by any cause beyond the control of Captiva, including, but not limited to, normal wear and tear, weathering, customer misuse/abuse/neglect, or acts of nature.
- 19) Doors shipped out of the continental US.
- 20) Any costs or charges relating to the replacement of the product, including transportation, shipping, removal, finishing, and installation.
- 21) Damage caused by failure of glazing, if the manufacturer's warranty period for that glazing has expired.

Extended warranty

5 YEAR EXTENDED WARRANTY - AVAILABLE ON CAPTIVA SELECT DOORS ONLY

The 5 Year option must be requested at the time of quoting/ordering the door unit. The extended warranty if requested is offered at an additional cost.

10 YEAR EXTENDED WARRANTY - AVAILABLE ON CAPTIVA TRADITIONAL DOORS ONLY

The warranty described above is extended for a period of 10 (ten) years with the additional requirement of adding multipoint locking hardware, such as Trilennium, that provides a minimum of three latching points on the lock edge or top and bottom of the door. The 10 Year option must be requested at the time of quoting/ordering the door unit. The extended warranty if requested is offered at an additional cost.

Warranty Claims

Warranty claims must be submitted within 30 days of discovery of the believed issue. Claims must be submitted via email to techsupport@northatlanticcorp.com or in writing to Captiva Wood Doors Warranty Claims, 1255 Grand Army Hwy, Somerset, MA, 02726 and must include proof of purchase of product.

Express Limitation

This warranty sets forth Captiva's maximum liability for its products. No other warranty, expressed or implied, with respect to its product is made. Captiva's liability is limited to the refund of the purchase price or repair or replacement of the defective product. This warranty is non-transferable.

Disclosure

Formal acceptance of this warranty is not required. By accepting delivery of the product, the customer is also accepting the terms and conditions of the Captiva Doors limited warranty.

NO OVERHANG WARRANTY - CAPTIVA TRADITIONAL DOORS

No Overhang 5 Year Warranty. Available when requested at an additional cost and requires 3-Point Locking System.

No Overhang 10 Year Warranty. Warranty must be requested at time of quoting/ordering. Certain restrictions apply in addition to standard warranty terms.

Use and care guide.



CAPTIVA
wood doors

DOOR HANDLING AND STORAGE

- 1) Doors should be handled with clean gloves to prevent leaving dirt and oil stains on the door face.
- 2) Do not drag or slide doors along any surface that could damage the door. Do not drag or slide doors across each other.
- 3) Doors must be stored in a dry, ventilated area in an enclosed building. Never store doors outside.
- 4) Doors should be stored flat on a level surface. When stacking doors, place a 2x4 at the top and bottom of each door, 12" from the edge. Place a third 2x4 in the middle for a center support. Cover doors to keep clean, but ensure proper air circulation exists.
- 5) Never lean doors against a wall.
- 6) Never store doors in direct sunlight.
- 7) If doors are to be stored for longer than one week, all six sides of the doors must be sealed with a non-water based sealer or primer to prevent excessive moisture penetration or drying.

DOOR FITTING AND HANGING

- 1) Give doors sufficient time to acclimate to the humidity of the surrounding area before hanging. In areas of extreme humidity, allow for a minimum of 72 hours.
- 2) When hanging a door, allow clearance for swelling of the door or frame in extremely damp, high humidity environments. Adequate clearance ranges from 1/16" to 1/8" in width and height.
- 3) If trimming is needed, trim no more than 1" at bottom of door and 1/4" at each side. Do not trim the top of the door.

OVERHANG GUIDELINES

- 1) An adequate overhang will help minimize damage caused by exposure to the elements. Adequate overhang length is a minimum extension of one-half the distance from the bottom of the door to the bottom of where the overhang begins, and at least one and half times the width of the door.
- 2) If you are unable to achieve an adequate overhang, please consult your Captiva representative. We offer limited warranties for doors without overhangs that meet specific requirements.

DOOR FINISHING

- 1) Avoid use of dark stains or dark paint in areas exposed to direct sunlight.
- 2) Prior to finishing, sand all surfaces of the door using the appropriate grit sandpaper. Sand the door following the direction of the grain. Ensure that all marks, fingerprints, and scratches are removed.
- 3) Prior to staining, apply a clear sanding sealer or conditioner in order to improve finished look.
- 4) Carefully seal all edges including the top and bottom of the door and areas routed for hardware with a minimum of three finish coats of a high quality paint or varnish.
- 5) When finishing glazed doors, apply top coat generously to bridge between wood and glass. Lap paint 1/16" to protect against moisture penetration.
- 6) The tops of all outswing doors must be flashed for weather.
- 7) Exterior sealers must contain UV inhibitors to protect the door from sunlight.
- 8) Carefully follow instructions from the manufacturer of the finish.

FINISH MAINTENANCE

- 1) Exterior sealers will weaken over time due to exposure and will require annual maintenance. Inspect door at least once per year and refinish as necessary.
- 2) Signs that your door requires finish restoration include dryness, raised grain, minor surface checks, dark streaks, or a whitish cast.
- 3) Please contact a Captiva representative if you have any questions/concerns about finish maintenance.

NO OVERHANG WARRANTY NOW AVAILABLE: CAPTIVA TRADITIONAL SERIES ONLY

No Overhang 5 Year Warranty

Available when requested at an additional cost and requires 3-Point Locking System.

No Overhang 10 Year Warranty.

Warranty must be requested at time of quoting/ordering. Certain restrictions apply in addition to standard warranty terms.

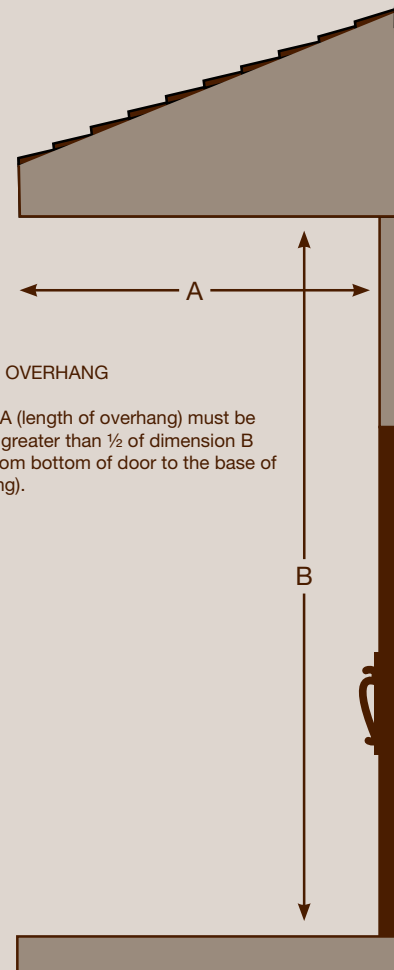

REQUIRED OVERHANG

Dimension A (length of overhang) must be equal to or greater than 1/2 of dimension B (distance from bottom of door to the base of the overhang).



Maintain your finish with Klima's Aquatech Retoning Liquid (TN030), available from your sales rep.



CAPTIVA
wood doors

Architectural specifications.

ARCHITECTURAL SPEC:

Door construction, unless specified differently shall include a stave core method that uses a laminated stable wood core sandwiched between veneers. Captiva Traditional Doors use 1/4" solid veneers on all stiles and rails with matching edges to help prevent warp or distortion. Captiva Select Doors use laminated stable wood cores sandwiched between 1/8" veneers. A unique "beaded tenon" inserted by hand is used instead of dowels creating a similar mortise and tenon connection on all stiles and rails. All raised panels used in both methods shall be manufactured using double panel technology, which virtually eliminates cracking panels by allowing independent movement. Both types of construction are time tested methods and backed by our full warranties.

Multi-lite doors, as true divided lite (TDL), available in Captiva Traditional or Select, with 1/8" single pane, 5/8" IG glass, or 5/8" Low E glass and wood stops applied to the exterior. Muntin bar widths are 1", 1-1/8", and 1-3/8". Simulated divided light (SDL) with 7/8" SDL bar, and 11/16" duplex muntins. Wood bars applied to both faces of door with the loose stop toward the exterior. SDL is available in Captiva Select doors only.

AIA/CES COURSE: CWD315 Stile & Rail Door Construction

This course shows the different styles of wood doors, discusses how stile and rail doors are constructed, introduces the various components and the best wood species to select. The course also highlights other components added to the door that are necessary to make the "door system" functional.

North Atlantic Corp Provider # 40107222

Learning Units: 1 | LU



Captiva Wood Doors website.



EXPLORE

- Our door designs
- Prefinishing in our facility
- Commercial capabilities
- Hardware for every door
- Construction details
- Made in the USA

INTERACTIVE SPEC BOOK AND CAPTIVA DOOR CATALOG AVAILABLE ONLINE

- Access specifications for each individual Captiva door style
- Print or save the PDF for your reference
- Download DWG files for each door style
- Download the Captiva catalog



www.CaptivaWoodDoors.com



CAPTIVA
wood doors

Follow your bliss and the universe will open doors
where there were only walls. - Joseph Campbell

 **Cleary**
MILLWORK
Wholesale Doors
COMMERCIAL DIVISION

2049 Silas Deane Hwy, Ste 1A | Rocky Hill, CT 06067
800.486.7600 phone | 800.486.0513 fax

1255B Grand Army Hwy | Somerset, MA 02726
800.899.4533 phone | 508.235.4431 fax

120 Defreest Drive, Ste 19 | Troy, NY 12180
800.350.0448 phone | 518.861.5061 fax

Wholesale Doors Commercial Division
44 Green River Way | Watertown, MA 02471
800.225.4252 phone | 617.926.6330 fax

www.ClearyMillwork.com