



SCHLAGE

Residential architectural guide

Rev. 5/15





Table of contents

Electronics

Connected locks

Home automation Schlage Connect™	4
-------------------------------------	---

Electronic locks

Schlage Touch™ deadbolts & locks	5
Keypad locks FE285 handlesets	6-7

Mechanical locks

Schlage deadbolts & handlesets	8-9
Schlage knobs & levers	10
Schlage decorative collections	11
Schlage J Series	12-13

Multi-family

Schlage programmable electronic deadblt	14
Schlage electronic interconnected lock	15
Multi-family readers and credentials	16
Mechanical interconnected locks	17
Mechanical deadbolts	18-19

Builders hardware

20-21



Residential electronic deadbolts and locksets

Connected deadbolts & levers



BE469NX
Camelot (CAM)



BE469NX
Century (CEN)



BE468NX
Camelot (CAM)



BE468NX
Century (CEN)



BE369NX
Camelot (CAM)



FE599NX
Camelot x Accent Lever

Schlage connected locks use Z-Wave®, a wireless technology that makes your house smarter, safer, and far more convenient. When these locks are paired with a compatible Z-Wave® home automation system, homeowners can remotely control, manage, and monitor access to their home*.

ANSI A156.36-2010 (deadbolt only)

BE469NX - Connect™ deadbolt with alarm

- Grade 1
- Autothrow deadbolt is activated from outside by pressing the Schlage button
- Deadbolt automatically retracted from outside by entering valid user code
- Key can be used to unlock as backup
- Built-in Alarm Technology alerts home owners to potential security threats

BE468NX - Connect™ deadbolt

- Grade 2
- Autothrow deadbolt is activated from outside by pressing the Schlage button
- Key can be used to unlock as backup

ANSI A156.2-2003

FE599NX - Connected keypad lever

- Grade 2
- Locks manually operated from outside after entering valid user code

ANSI A156.36-2010

BE369NX - Connected keypad deadbolt

- Grade 2
- Locks manually operated from outside after entering valid user code

*Home automation features are dependent upon the system provider
Z-Wave is a registered trademark of Zensys Inc, and/or its subsidiaries

Finishes

Function	605	608	609	613	618	619	620	622	625	626	716
BE469 Camelot	▪								▪		▪
BE469 Century								▪	▪	▪	▪
BE468 Camelot	▪								▪		▪
BE468 Century								▪	▪	▪	▪
BE369 Camelot	▪										▪
FE599 Camelot x Accent	▪										▪

Standard features / configurations

	Connect™ deadbolt BE469NX	Connected keypad deadbolt BE369NX	Connected keypad lever FE599NX
Certification:	ANSI A156.36-2010 Grade 1	ANSI A156.36-2010 Grade 2	ANSI A156.2-2003 Grade 2
Backset:	2 ³ / ₈ " or 2 ³ / ₄ "	2 ³ / ₈ " or 2 ³ / ₄ "	2 ³ / ₈ " or 2 ³ / ₄ "
Strike:	1 ¹ / ₈ " x 2 ³ / ₄ " round corners, strike reinforcer	1 ¹ / ₈ " x 2 ³ / ₄ " round corners, strike reinforcer	1 ⁵ / ₈ " x 2 ¹ / ₄ " radius corner, full lip, latch strike
Key & cylinder:	1 key, 5-pin, C keyway	2 keys, 5-pin, C keyway	2 keys, 5-pin, C keyway
Door thickness:	1 ³ / ₈ " to 1 ³ / ₄ "; thick door kit extends 1 ⁷ / ₈ " to 2 ¹ / ₂ "	1 ³ / ₈ " to 1 ³ / ₄ "	1 ³ / ₈ " to 1 ³ / ₄ "
Product dimensions: (wxhxd)	ext: 3" x 4 ³ / ₄ " x 1" int: 3" x 8" x 2"	ext: 3 ¹ / ₈ " x 5 ¹ / ₂ " x 2 ¹ / ₈ " int: 3 ¹ / ₄ " x 7 ¹ / ₂ " x 2 ¹ / ₄ "	ext: 6 ⁷ / ₈ " x 3" x 2 ³ / ₄ " int: 3 ¹ / ₄ " x 8 ¹ / ₄ " x 2 ³ / ₄ "
Communications:	900 MHz (Z-Wave® RF)**	900 MHz (Z-Wave® RF)**	900 MHz (Z-Wave® RF)**
Operating temps:	Ext: -35C to 66C Int: -10C to 49C	Ext: -30C to 66C Int: -10C to 49C	Ext: -30C to 66C Int: -10C to 49C
Battery:	4 AA	9V, 3AA	9V, 4AA
Codes:	Pre-set, unique 6-digit programming code, 2 pre-set unique 4-digit user codes, 30 user code capacity (4-8 digits)	Pre-set, unique 6-digit programming code, 2 pre-set unique 4-digit user codes, 19 code capacity	Pre-set, unique 6-digit programming code, 2 pre-set unique 4-digit user codes, 19 code capacity

** Z-Wave is a registered trademark of Zensys Inc, and/or its subsidiaries.
Warranty: 3 year electronics, limited lifetime mechanical and finish

Door preparation

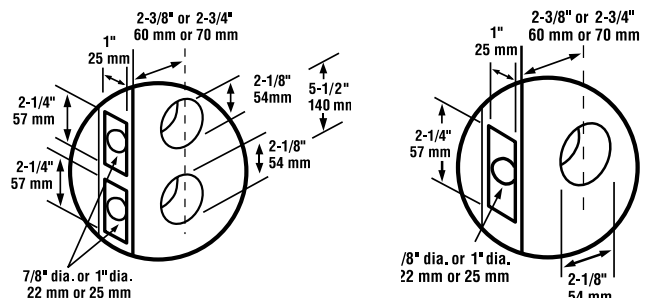



Residential electronic deadbolts and locksets

BE Series Schlage Touch™ non-connected deadbolts



BE375 Series
Camelot



BE375 Series
Century

BE-Series Schlage Touch™ deadbolts

Finishes available

Function	Style/Design	605	608	609	618	619	625	626	505	716	613	620	621	622
BE375	Camelot	▪		▪		▪	▪	▪		▪				▪
BE375	Century					▪	▪	▪		▪				▪

FE Series Schlage Touch™ non-connected levers



FE695 Series
Camelot x Accent



FE695 Series
Camelot x Flair



FE695 Series
Century x Broadway



FE695 Series
Century x Latitude



FE695 Series
Century x Merano

FE-Series Schlage Touch™ lever locks

Finishes available

Function	Style/Design	605	608	609	618	619	625	626	505	716	613	620	621	622	
(CAM) Camelot x															
FE695	Camelot x Accent	▪		▪		▪	▪	▪		▪				▪	
FE695	Camelot x Flair	▪		▪		▪	▪	▪		▪				▪	
(CEN) Century x															
FE695	Century x Broadway					▪	▪	▪		▪				▪	
FE695	Century x Elan							▪							
FE695	Century x Latitude					▪	▪	▪		▪				▪	
FE695	Century x Merano					▪	▪	▪		▪				▪	

With Schlage Touch™, no key means there's nothing to lose, nothing to fiddle with, and—for intruders—nothing to pick. All in a slim profile that's every bit as sleek as it is strong

**ANSI/BHMA Grade 2
Schlage Touch™ Locks**

BE375 – Touchscreen deadbolt

- Deadbolt retracted by entering valid user code then rotating outside thumbturn, or by inside thumb turn
- Deadbolt thrown by using outside thumbturn after pressing Schlage button, or by inside thumbturn

FE695 – Touchscreen lever

- Unlocked by valid user code from outside
- Inside knob or lever always unlocked
- Flex Lock: adjust inside thumb turn to keep door locked or unlocked

Latches and strikes

FE Keypad levers

Latches

16-086	Dual option (round, drive in) STANDARD
16-207	Square corner
16-211	Triple option (round, square, drive in)
16-203	UL Listed square corner with firecup
16-204	UL Listed round corner with firecup

Strikes

10-027	Round corner full lip - STANDARD
10-001	Square corner T Strike
10-026	Square corner full lip
10-058	Circular adjustable
10-063	Dual strikes (round & square full lip)
10-025	ANSI square corner

BE Keypad deadbolts

Latches

12-321	Dual option (round, drive in) STANDARD
12-288	Square corner
12-287	Triple option (round, square, drive in)
12-294	UL Listed square corner with firecup
12-397	UL Listed round corner with firecup

Strikes

10-116	Round corner strike with reinforcer - STANDARD
10-092	Round corner full lip strike
10-094	Square corner strike with reinforcer

Standard features / configurations

	Schlage Touch™ electronic deadbolt BE375	Schlage Touch™ electronic lever FE695
Certification	ANSI/BHMA Grade 2	ANSI/BHMA Grade 2
Product dimensions (inches) (w x h x d)	3 x 5.4 x 5.2	3 x 5.4 x 7.9
Weight	3.4 lbs	4.5 lbs
Warranty	3 year electronics, limited lifetime mechanical and finish	3 year electronics, limited lifetime mechanical and finish
Battery	9V battery (1)	9V battery (1)
Latch throw	1"	1/2"throw, 7/8" housing diameter
Cylinder	None	None
Door thickness	1 3/8" to 1 3/4" thick door kit extends 1 7/8" to 2 1/2"	1 3/8" to 1 3/4" no thick door kit
Cross bore	2 1/8"	2 1/8"
Latch faceplate size	1" x 2 1/4" Dual Option - Round Corner + Drive-in	1" x 2 1/4" Dual Option - Round Corner + Drive-in
Latch/backset	2 3/8" OR 2 3/4" adjustable	2 3/8" OR 2 3/4" adjustable
Latch faceplate options	Deadbolt latch, round, square & drive-in	Dead latch, round, square & drive-in
Strike	1 1/8" x 2 3/4" round corners, strike reinforce	1 5/8" x 2 1/4", round corner, full lip latch strikes
Keys	None	None
Codes	2 pre-set unique 4-digit user codes, storage of up to 19 user codes	2 pre-set unique 4-digit user codes, storage of up to 19 user codes
Operating temperatures	Outside lock body (exterior mounted): -35C to 66C Inside lock body (interior mounted): -10C to 50C	Outside lock body (exterior mounted): -35C to 66C Inside lock body (interior mounted): -10C to 50C

Door preparation

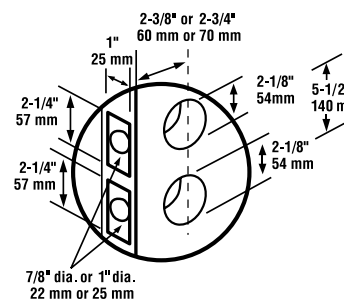

BE375

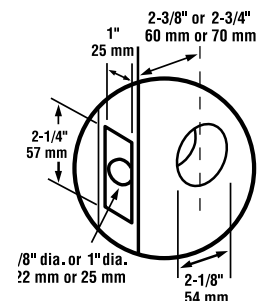

FE695



Residential electronic deadbolts and locksets

BE and FE Series Keypad deadbolt

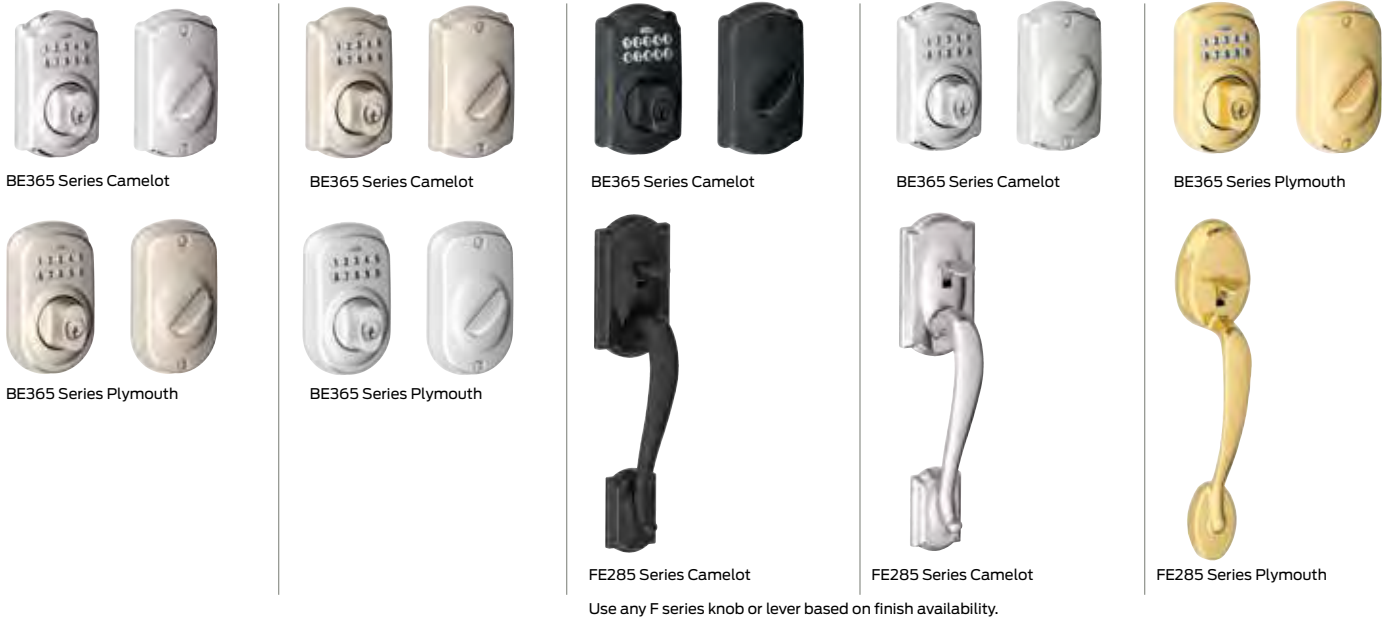

Convenient. Secure. Stylish.

Experience keyless freedom with Schlage keypad locks, revolutionary products that bring security to a new level. Our keypad locks combine the convenience of keyless entry with the superior quality you expect from Schlage.

Security and quality

- Grade 2 ANSI/BHMA certified
- Patented commercial-grade clutching motor drive; tested to one million cycles
- Vandal-resistant, free-spinning deadbolt turn and clutching knob/lever design
- Code control; 6-digit programming code required to add and delete user codes
- Warning sounds after four incorrect codes entered; keypad disabled for 30 seconds
- Mechanical key override; patent pending

Convenience

- Convenient keyless access; no keys to hide, lose or forget
- Fits standard door prep; no additional mounting holes required
- Pre-set with random 6-digit programming code and two random 4-digit user codes; no programming required
- 19-user code capacity; 10,000 user code combinations
- Easily programmed right at the keypad; no need to remove inside escutcheon
- Blue LEDs illuminate the keypad on demand for evening use
- Locks can be re-keyed to match existing locks
- 9-volt alkaline battery included, low battery warning and average 3-year life
- Easy access to replace battery
- FE595 model with Flex-lock feature easily switches between lock and passage modes
- FE575 model with Auto-lock feature locks automatically

Specifications

Applications:	Residential single- and multi-family doors
Keying:	5-pin tumbler with two keys per lock; stock locks are keyed 5-pin
Door range:	1 ³ / ₈ " to 1 ³ / ₄ " thick (35mm - 44mm) standard; thick door kit available on BE365
Backset:	Universal latches and deadbolts fit 2 ³ / ₈ " (60 mm) or 2 ³ / ₄ " (70 mm) backsets

Warranty: 3 year electronics, limited lifetime mechanical and finish

Door preparation

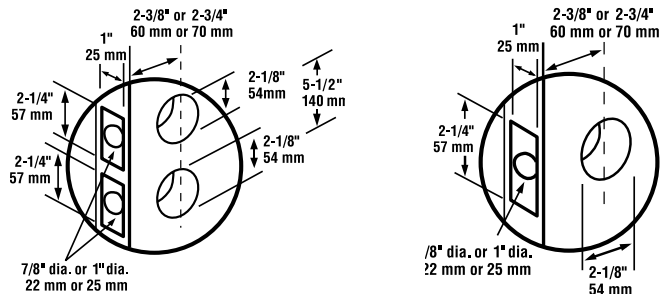

Finishes

Function	605	608	609	613	618	619	620	622	625	626	716
BE365 Camelot	■	■	■	■	■	■	■	■	■	■	■
BE365 Plymouth	■	■	■	■	■	■	■	■	■	■	■
FE285 Camelot	■	■	■	■	■	■	■	■	■	■	■
FE285 Plymouth	■	■	■	■	■	■	■	■	■	■	■

FE285 available in standard handleset and knob and lever finish options, see page 9 & 10.

BE Series and FE Series residential keypad deadbolts and locksets

Keypad entry lock



FE595 Series
Camelot x Accent lever



FE595 Series
Plymouth x Flair lever



FE595 Series
Plymouth x Plymouth knob



FE595 Series
Camelot x Georgian knob



FE575 Series
Camelot x Accent lever



FE575 Series
Plymouth x Elan lever



FE575 Series
Plymouth x Plymouth Knob

FE595 - Keypad Entry with Flex-Lock

- Flex-locking, switch between unlocked or automatic re-locking
- Unlocked by valid user code from outside
- Inside knob or lever always unlocked
- Key can be used to unlock as back-up

FE575 - Keypad Entry with Auto-Lock

- Auto-locking, automatically re-locks after 5 seconds
- Unlocked by valid user code from outside
- Inside knob or lever always unlocked
- Key can be used to unlock as back-up

Standard features / configurations

Warranty	Limited lifetime mechanical and finish warranty, 3 year electronics warranty
Keypad lock latch	1" x 2 1/4" (25mm x 57mm) latch with radius corner faceplate, 7/8" (22mm) housing diameter, 1/2" (13mm) throw spring latch with square corner and circular drive-in faceplates
Keypad deadbolt latch	1" x 2 1/4" (25mm x 57mm) radius corner faceplate, 1" (25mm) housing diameter, requires 1" (25mm) edge bore, 1" (25mm) throw with square corner and circular drive-in faceplates
Latch strikes	1 5/8" x 2 1/4" (41mm x 57mm), square and radius corner, full lip
Deadbolt strike	2 3/4" (70mm), round corner, latch strike, metal strike reinforcer
Cylinder	5-pin solid brass, keyed 5-pin, C keyway, keyed different (KD)

General:

- Minimum 5 1/2" (140mm) center-to-center distance between cross bore holes
- 9-volt battery included with average three-year battery life
- Silicone rubber, wear-resistant buttons with LED backlight
- ANSI A 156.5-2001 Grade 2 auxiliary locks, ANSI A 156.2-2003 bored locks and latches
- FCC Part 15
- CE mark
- BE365 and FE285 available UL Listed (box pack only)

Finishes

BE and FE Series	605	608	609	613	618	619	620	622	625	626	716
BE365 Camelot	■	■	■	■	■	■	■	■	■	■	■
BE365 Plymouth	■	■	■	■	■	■	■	■	■	■	■
FE595 Camelot x Accent	■	■	■	■	■	■	■	■	■	■	■
FE595 Camelot x Georgian	■	■	■	■	■	■	■	■	■	■	■
FE595 Plymouth x Flair	■	■	■	■	■	■	■	■	■	■	■
FE595 Plymouth x Plymouth	■	■	■	■	■	■	■	■	■	■	■
FE575 Camelot x Accent	■	■	■	■	■	■	■	■	■	■	■
FE575 Plymouth x Flair	■	■	■	■	■	■	■	■	■	■	■
FE575 Plymouth x Elan	■	■	■	■	■	■	■	■	■	■	■
FE575 Plymouth x Jazz	■	■	■	■	■	■	■	■	■	■	■
FE575 Plymouth x Plymouth	■	■	■	■	■	■	■	■	■	■	■



B Series mechanical deadbolts



B60, B62R Series

Grade 1 for high-traffic residential or commercial use.

Shown: B60 single cylinder



Standard features

- Extra security with a full 1" (25mm) throw deadbolt with a concealed hardened steel roller to prevent cutting or sawing the bolt
- 5-minute, 3-step installation
- Anti-pick shield protects against hammer and crow bar attacks
- Available in single and double cylinder
- Available with full-sized interchangeable core (B60R, B62R)
- Limited lifetime mechanical and finish

Specifications

Certifications	Exceeds ANSI/BHMA certified A156.5 - 2001, Grade 1, UL Listed for 3-hour fire door (Grade 2 with FSIC)
Applications	Medium-traffic deadbolt, Grade 1 residential or commercial, exterior, new construction and retrofit applications
Deadbolt	1" x 2 1/4" (25mm x 57mm), square and round corner faceplate included, 1" (25mm) housing diameter, 1" (25mm) throw

Finishes

Series	505	605 US3	606 US4	608	609 US5	612 US10	613 US10B	618	619 US15	620 US15A	621 US17A	622 US19	625 US26	626 US26D	643/716 US11
B60	▪	▪	▪	▪	▪	▪	▪	▪	▪	▪	▪	▪	▪	▪	716
B62R	▪	▪	▪	▪	▪	▪	▪	▪	▪	▪	▪	▪	▪	▪	716

Door preparation

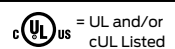
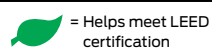
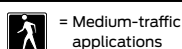
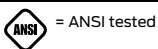
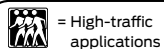
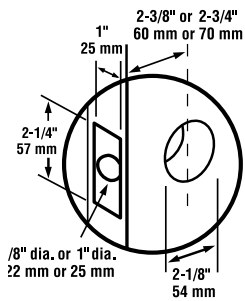

Residential F Series handlesets

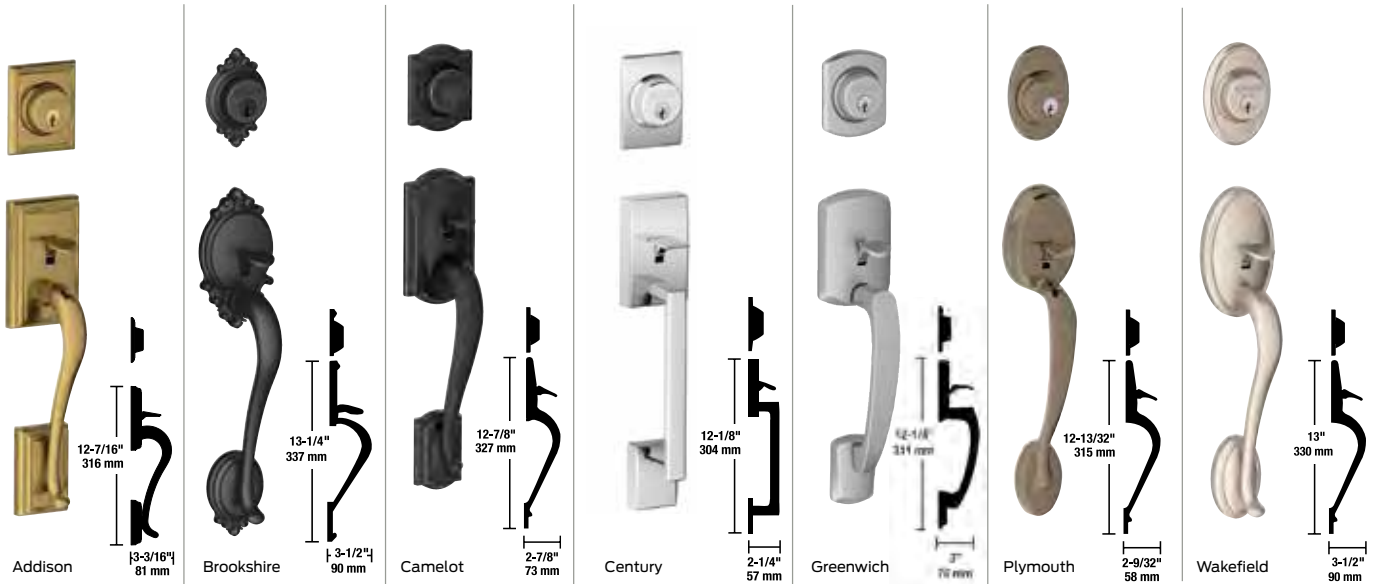

Standard features

- Grade 1 highest residential security rating
- Limited lifetime mechanical and finish warranty
- Finishes on latches, strikes, and screws match finish on grip handleset
- Adjustable throughbolt can move up and down 1-1/2" to fit a variety of pre-existing holes

Finishes

Handlesets	605	608	609	613	618	619	620	621	622	625	626	716
Addison	■		■			■	■	■	■	■		■
Brookshire	■		■			■			■			■
Camelot	■	■	■	■		■	■	■	■	■	■	■
Century	■				■				■	■	■	■
Greenwich					■	■			■	■	■	■
Plymouth	■		■	■		■	■	■	■	■	■	■
Wakefield	■	■	■	■	■	■	■	■	■	■	■	■

Door preparation

Two piece handleset

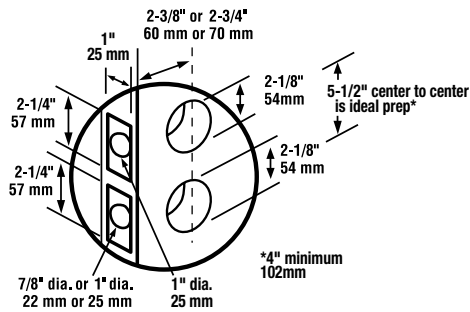

Residential lock finishes



= Helps meet LEED certification

Residential F Series knobs & levers

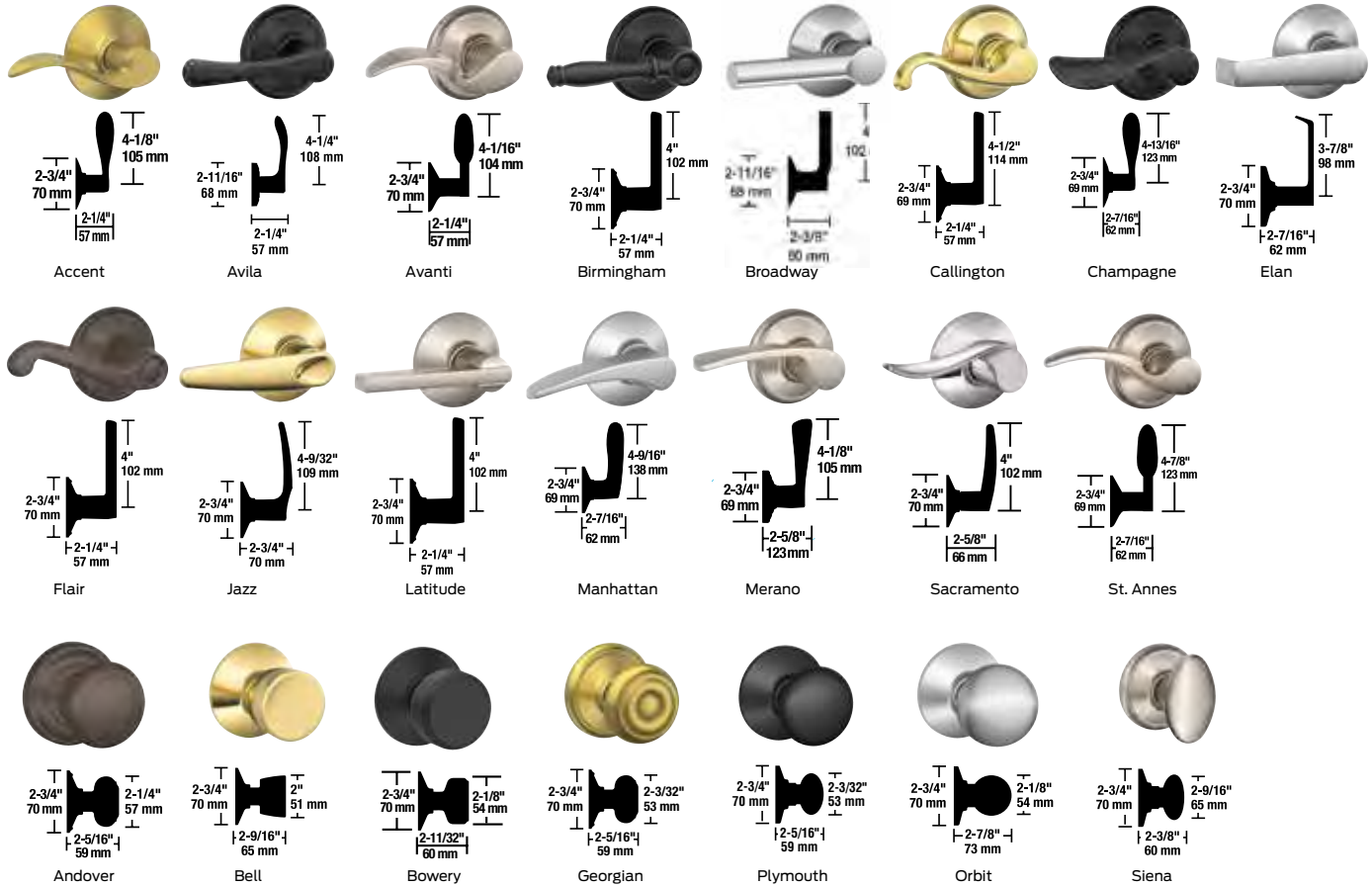

Standard features

- Limited lifetime mechanical and finish warranty
- Field-reversible levers on privacy, passage and keyed functions
- Key-removable outside knobs or levers for easy cylinder replacement
- Meets 400,000 cycle ANSI Grade 2 requirements
- Concealed screws on Andover and Greyson style roses

Latches and strikes

Latches: 1" x 2 1/4" (25mm x 57mm), 1/2" (13mm) throw standard. Dual option faceplates, including 1 1/8" (29mm) round corner and circular drive-in, are standard for passage and privacy functions. Square corner faceplates available.

Strikes: Full lip, 1/4" (6mm) radius corner, 1 5/8" x 2 1/4" (41mm x 57mm), 1 1/8" (29mm) lip, #10-027, standard. Optional strikes: full lip; square corner; circular drive-in, ANSI 1 1/4" x 4 7/8" (32mm x 124mm), 1 3/16" (30mm) lip. UL Listed locks are furnished with #10-001 T strike, 1 1/8" x 2 3/4" (29mm x 70mm), 1 1/8" (29mm) lip (also available with standard product).

Specifications

Applications	Residential single-family and multi-family use
Certifications	ANSI A156.2, 1996, Series 4000 Grade 2. UL Listed locks for 3-hour fire doors are furnished with #10-001 T strike, 1 1/8" x 2 3/4" (29mm x 70mm), 1 1/8" (29mm) lip (also available with standard product). Assembled to order when specified with "F" suffix. Example: F51F
Exposed trim	Levers are plated to match finishes indicated.
Keying	5-pin tumbler C keyway with two keys. All F51A functions offer interior emergency exit feature.
Door range	1 3/8" to 1 3/4" (35mm to 44mm) standard.
Backset	Fits either 2 3/8" (60mm) or 2 3/4" (70mm) backset.

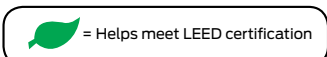

Residential decorative trim

Decorative Collections

Our exceptional collections are just the beginning of the expanded choices available both now and in the future — paired with lever and knob designs and finishes in a generous number of combinations to meet the style and security needs of this demanding market:

- Inspired design collections ranging from traditional to contemporary
- Numerous distinctive finishes to choose from
- Pair with your choice of complementing Schlage handlesets
- Solid die-cast construction for durability

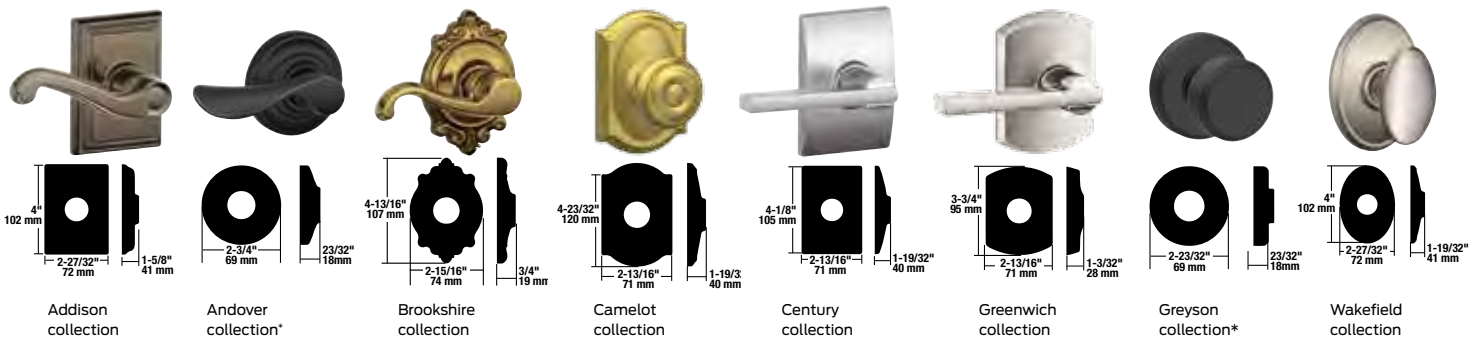

*Features concealed screws

Finishes

Knobs	605	608	609	613	618	619	620	621	622	625	626	716
Andover	▪	▪	▪	▪	▪	▪	▪	▪	▪	▪	▪	▪
Bell	▪	▪	▪	▪	▪	▪	▪	▪	▪	▪	▪	▪
Bowery	▪	▪	▪	▪	▪	▪	▪	▪	▪	▪	▪	▪
Georgian	▪	▪	▪	▪	▪	▪	▪	▪	▪	▪	▪	▪
Orbit	▪	▪	▪	▪	▪	▪	▪	▪	▪	▪	▪	▪
Plymouth	▪	▪	▪	▪	▪	▪	▪	▪	▪	▪	▪	▪
Siena	▪	▪	▪	▪	▪	▪	▪	▪	▪	▪	▪	▪
Levers												
Accent	▪	▪	▪	▪	▪	▪	▪	▪	▪	▪	▪	▪
Avanti	▪	▪	▪	▪	▪	▪	▪	▪	▪	▪	▪	▪
Avila	▪	▪	▪	▪	▪	▪	▪	▪	▪	▪	▪	▪
Birmingham	▪	▪	▪	▪	▪	▪	▪	▪	▪	▪	▪	▪
Broadway	▪	▪	▪	▪	▪	▪	▪	▪	▪	▪	▪	▪
Callington	▪	▪	▪	▪	▪	▪	▪	▪	▪	▪	▪	▪
Champagne	▪	▪	▪	▪	▪	▪	▪	▪	▪	▪	▪	▪
Elan	▪	▪	▪	▪	▪	▪	▪	▪	▪	▪	▪	▪
Flair	▪	▪	▪	▪	▪	▪	▪	▪	▪	▪	▪	▪
Jazz	▪	▪	▪	▪	▪	▪	▪	▪	▪	▪	▪	▪
Latitude	▪	▪	▪	▪	▪	▪	▪	▪	▪	▪	▪	▪
Manhattan	▪	▪	▪	▪	▪	▪	▪	▪	▪	▪	▪	▪
Merano	▪	▪	▪	▪	▪	▪	▪	▪	▪	▪	▪	▪
Sacramento	▪	▪	▪	▪	▪	▪	▪	▪	▪	▪	▪	▪
St. Annes	▪	▪	▪	▪	▪	▪	▪	▪	▪	▪	▪	▪

Knobs and levers - Decorative Collection

	605	608	609	613	618	619	620	621	622	625	626	716
Addison	▪	▪	▪	▪	▪	▪	▪	▪	▪	▪	▪	▪
Andover	▪	▪	▪	▪	▪	▪	▪	▪	▪	▪	▪	▪
Brookshire	▪	▪	▪	▪	▪	▪	▪	▪	▪	▪	▪	▪
Camelot	▪	▪	▪	▪	▪	▪	▪	▪	▪	▪	▪	▪
Century	▪	▪	▪	▪	▪	▪	▪	▪	▪	▪	▪	▪
Greenwich	▪	▪	▪	▪	▪	▪	▪	▪	▪	▪	▪	▪
Greyson	▪	▪	▪	▪	▪	▪	▪	▪	▪	▪	▪	▪
Wakefield	▪	▪	▪	▪	▪	▪	▪	▪	▪	▪	▪	▪

Deadbolts - Decorative Collection

	505	605	608	609	613	618	619	620	621	622	625	626	716
Addison	▪	▪	▪	▪	▪	▪	▪	▪	▪	▪	▪	▪	▪
Brookshire	▪	▪	▪	▪	▪	▪	▪	▪	▪	▪	▪	▪	▪
Camelot	▪	▪	▪	▪	▪	▪	▪	▪	▪	▪	▪	▪	▪
Century	▪	▪	▪	▪	▪	▪	▪	▪	▪	▪	▪	▪	▪
Greenwich	▪	▪	▪	▪	▪	▪	▪	▪	▪	▪	▪	▪	▪
Wakefield	▪	▪	▪	▪	▪	▪	▪	▪	▪	▪	▪	▪	▪

Door Preparation

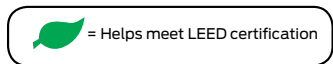
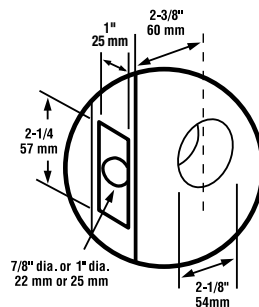



Residential J Series

Grade 3 Handleset/deadbolt designs

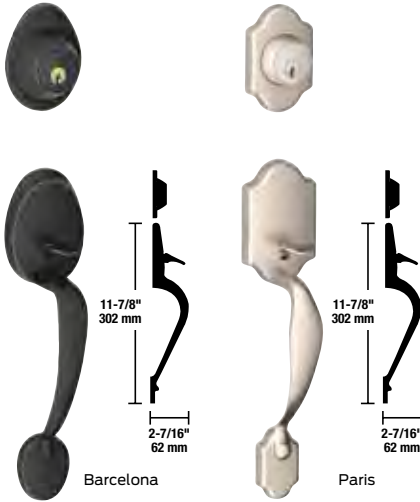

Handleset specifications

Applications	Residential single-family and multi-family use
Certifications	ANSI A156.5, 2001, Grade 3.
Exposed trim	Handlesets are zinc-based; plated to match finishes indicated.
Keying	Schlage C keyway with two brass keys. Locks are keyed 5-pin.
Door Range	1 ³ / ₈ " to 1 ³ / ₄ " (35mm to 44mm) standard.
Backset	Universal latch standard, fits either 2 ³ / ₈ " (60mm) or 2 ³ / ₄ " (70mm) backsets.
Warranty	Limited lifetime mechanical warranty, five-year finish warranty.
UL Listing	Single cylinder deadbolt/handleset available with UL Listing - box pack only.

Latches and strikes

Latches: 1" x 2¹/₄" (25 mm x 57 mm), 1/2" (13 mm) throw standard. Dual option faceplates including 1¹/₈" (29 mm) round corner and circular drive-in are standard for passage and privacy functions. Keyed functions also come with 1¹/₈" (29 mm) square corner faceplates standard, in addition to round corner and circular drive-in. 1¹/₈" (29 mm) faceplate adaptors available.

Strikes: Full lip, 1⁵/₈" x 2¹/₄" (41mm x 57mm), 1¹/₈" (29mm) lip, #10-026, standard. Optional strikes: full lip, 1/4" (6mm) radius round corner; circular drive-in, ANSI 1¹/₄" x 4⁷/₈" (32mm x 124mm), 1³/₁₆" (30mm) lip. UL Listed locks are furnished with #10-001 T strike, 1¹/₈" x 2³/₄" (29mm x 70mm), 1¹/₈" (29mm) lip (also available with standard product).



JD60
JD Series single cylinder



JD80
JD Series one-sided deadbolt



JD81
JD Series one-sided deadbolt
w/ exterior plate

Deadbolt specifications

Applications	Residential single-family and multi-family use
Certification	ANSI A156.5, 2001 Grade 3.
Exposed trim	Wrought brass or bronze.
Keying	Schlage C keyway with two brass keys. Locks are keyed 5-pin.
Door range	1 ³ / ₈ " to 1 ³ / ₄ " (35mm to 44mm) standard.
Backset	Universal latch standard, fits either 2 ³ / ₈ " (60mm) or 2 ³ / ₄ " (70mm) backsets.
Warranty	Limited lifetime mechanical warranty, five-year finish warranty.
UL Listing	Single cylinder deadbolt product available with UL Listing - box pack only.

Finishes

Handlesets	605	608	609	618	619	620	622	625	630	716
Barcelona	■	■	■	■	■	■	■	■	■	■
Paris	■	■	■	■	■	■	■	■	■	■
Deadbolts										
JD60	■	■	■	■	■	■	■	■	■	■
JD80	■	■	■	■	■	■	■	■	■	■
JD81	■	■	■	■	■	■	■	■	■	■

*Discontinued; available while supplies last

Door preparation

See templates.

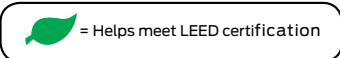
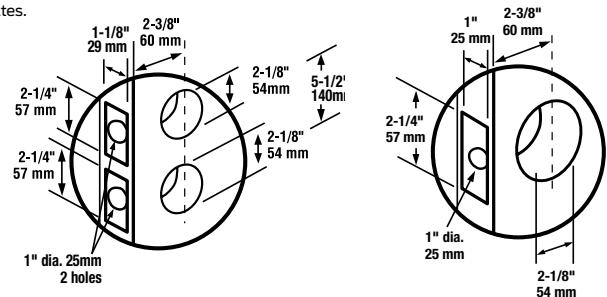

Residential J Series

Grade 3 Knob/lever designs

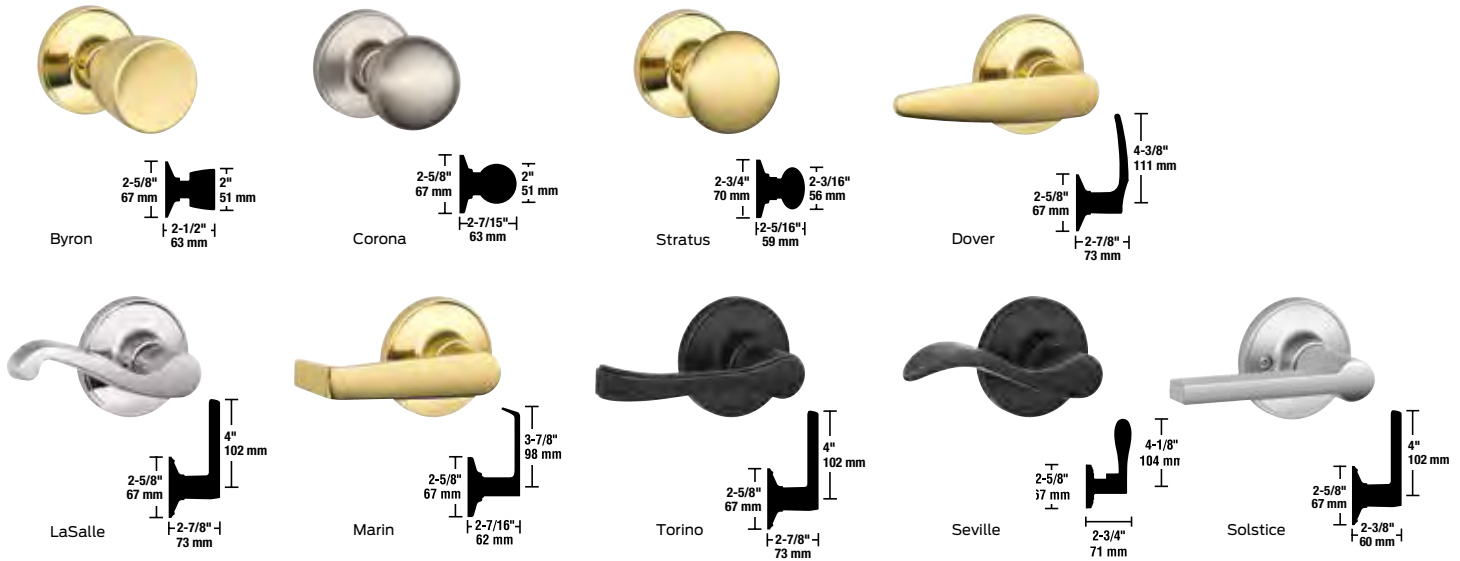

Dover, Marin and Torino lever designs are non-handed. LaSalle and Seville are reversible.

Specifications

Applications	Residential single-family and multi-family use
Certifications	ANSI A156.2, 1996, Series 4000 Grade 3.
Exposed trim	Levers are zinc-based; plated to match finishes indicated. Knobs are brass or stainless steel; plated to match finishes indicated.
Keying	5-pin tumbler Schlage C keyway with two brass keys.
Door range	1 ³ / ₈ " to 1 ³ / ₄ " (35mm to 44mm) standard.
Backset	Universal latch standard, fits either 2 ³ / ₈ " (60mm) or 2 ³ / ₄ " (70mm) backsets.
UL listing	Knobs/levers available with UL listing. Box pack only.

Finishes

Knobs	605	609	619	620	625	626	630	716
Byron	■	■					■	
Corona	■	■	■	■	■		■	■
Stratus	■	■	■		■		■	■
Dover	■	●					■	
Levers								
LaSalle	■	■	■					■
Marin			■				■	
Torino	■	■	■	●	■		■	■
Seville	■	■	■		■		■	■
Solstice			■		■	■		■

● Discontinued; available while supplies last

Standard features

- Limited lifetime mechanical warranty, five-year finish warranty
- Schlage C keyways can be keyed to Schlage locks for one-key convenience

Latches and strikes

Latches: 1" x 2¹/₄" (25 mm x 57 mm), 1/2" (13 mm) throw standard. Dual option faceplates, including 1¹/₈" (29 mm) round corner and circular drive-in, are standard for passage and privacy functions. Keyed functions also come with 1¹/₈" (29 mm) square corner faceplates standard, in addition to round corner and circular drive-in. 1¹/₈" (29 mm) faceplate adaptors available.

Strikes: Full lip, 1⁵/₈" x 2¹/₄" (41mm x 57mm), 1¹/₈" (29mm) lip, #10-026, standard. Optional strikes: full lip, 1/4" (6mm) radius round corner; circular drive-in, ANSI 1¹/₄" x 4⁷/₈" (32mm x 124mm), 1³/₁₆" (30mm) lip. UL Listed locks are furnished with #10-001 T strike, 1¹/₈" x 2³/₄" (29mm x 70mm), 1¹/₈" (29mm) lip (also available with standard product).

Door preparation

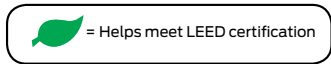
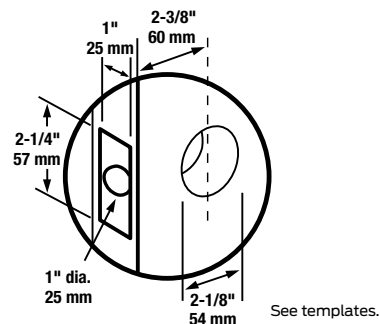



Multi-family programmable electronic deadbolt



BE367 Series
Plymouth



BE367 Series
Camelot

Benefits

- Eliminates deadbolt replacement and re-keying costs
- Reduces key management costs
- Prevents unauthorized key duplication
- Improves building security
- Increases property value
- Potential new revenue streams

Standard features

- Time and date controlled access
- Easy to install – fits on standard residential door preps
- Vandal resistant free-spinning deadbolt turn
- Up to 500 users
- Audit trail reports up to 1,000 events
- Battery powered – no wiring required
- Average 3-year battery life
- Low battery warning
- iButton credential required (sold separately)
- Hidden back-up mechanical key override

Finishes



505/605
Bright brass



609
Antique brass



613
Oil rubbed bronze



619
Satin nickel



620
Antique pewter



625
Bright chrome



626
Satin chrome



716
Aged bronze

Specifications

Latch	1" x 2 1/4" (25mm x 57mm) radius corner faceplate; 1" (25mm) housing diameter requires 1" (25mm) edge bore; 1" (25mm) throw with Triple Option™ square corner, radius corner and circular drive-in faceplates
Strikes	1 1/8" x 2 3/4" (29mm x 70mm), square corner, strike reinforcer
Backset	Adjustable backset, fits 2 3/8" to 2 3/4" (60mm - 70mm) backsets
Cylinder	5-pin, keyed 5-pin, C keyway, keyed different (KD)
Door range	1 3/8" to 1 3/4" (35mm - 44mm), thick door kit available for up to 2 1/2" (64mm)
Keys	5-pin, C-section
Hole distance	Minimum 5 1/2" (140mm) center-to-center distance between cross bore holes
Battery	9-volt battery included
Construction	All-metal chassis and escutcheons
Button	Silicone rubber, wear-resistant with LED backlight
Certifications	Available 3 hr. and 20 min. UL Listed; A 156.5-2001 Grade 2 auxiliary locks or Grade 2 ANSI/BHMA certified; FCC Part 15; CE mark

Door preparation

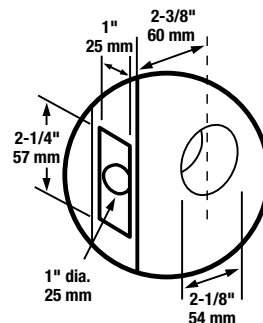

Multi-family electronic interconnect lock



FE210 F
Camelot

Benefits

- Eliminates deadbolt replacement and re-keying costs
- Reduces key management costs
- Prevents unauthorized key duplication
- Improves building security
- Increases property value
- Potential new revenue streams

Standard features

- Interconnect mechanism is adjustable
- Lever trim is non-handed and field reversible
- Grade 2
- UL 3-hour rating available
- Time and date controlled access
- Easy to install – fits on standard residential door preps
- Vandal resistant free-spinning deadbolt turn
- Up to 500 users
- Audit trail reports up to 1,000 events
- Battery powered – no wiring required
- Average 3-year battery life
- Low battery warning
- iButton credential required (sold separately)
- Hidden back-up mechanical key override

Finishes



505/605
Bright brass



609
Antique brass



619
Satin nickel



625
Bright chrome



626
Satin chrome



716
Aged bronze

Specifications

ANSI/BHMA	Grade 2 certified
UL rating	UL 3-hour rating available
Latch	UL latch comes with 1" x 2 1/4" square and round corner face plans (square corner standard, round corner included in package. 1" edge bore required)
Strikes	1 1/8" x 2 3/4" square corner deadbolt strikes and 2 1/4" x 1 5/8" square corner full lip latch strikes reinforcer. Dust box not included.
Backset	Adjustable backset, fits 2 3/8" or 2 3/4" backsets
Levers	All lever trim is non-handed and field reversible
Stile width	Minimum 4 1/2" for 2 3/8" backset, minimum 5" stile for 2 3/4"
Return to door	Saturn (SAT) and Neptune (NEP) are return to door code compliant
Cylinder	5-pin solid brass, layered 5-pin, C keyway, keyed different (KD)
Keys	5-pin, C section
Door range	1 3/8" to 1 3/4" standard. 1 3/4" to 2" optional. Must be specified.
Center to center	Fits 4" or 5 1/2" center to center door preps
Battery	9V battery included
Credential	Deadbolt is operated using iButton credential (sold separately)

Door preparation

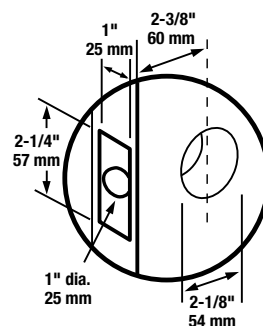



Multi-family readers and credentials

All the tools you need to manage every opening in your building.



Credential readers

- Accommodates interior, exterior, metal and metal installation environments
- Recognizes most proximity credentials, magnetic stripe, proximity, and smart credentials including aptiQ MIFARE Classic and MIFARE DESFire EV1 credentials
- FIPS 201-1 compliant
- NFC compatible
- Quick-connect wiring harness for easy installation
- Simple wiring - color scheme is identical to most readers
- Easy-to-install mounting bracket
- Tri-state LED
- Wiegand output
- Multiple reader cover color options
- Limited lifetime warranty



Credentials

- User/resident credentials
 - Over three billion code combinations
 - Cannot be duplicated
- Programming credentials
 - Required for lock programming
- Construction credentials
 - Used during construction; operates all electronic locks that haven't been programmed
- Vendor credentials
 - Used to allow temporary access to employees and vendors in conjunction with the Schlage vendor access management system software with Schlage access software

IBF-110

- Proximity Keyfob
 - 125 KHz proximity technology
- iButton
 - Durable stainless-steel packaging
 - Unique factory programmed 64-bit registration number
 - Momentary contact initiates identification
 - Data transfer rate of up to 16.3kbps

IBF-120

- Proximity Keyfob
 - 125 KHz proximity technology
- iButton
 - The iButton credential is a read-write credential
 - When used with a preferred third-party software provider, the Schlage Programmable Electronic Deadbolt (BE367) and Schlage Electronic Interconnect Lock (FE210) are non-touring capable with the iButton credential
 - Durable stainless-steel packaging
 - Unique factory programmed 64-bit registration number
 - Momentary contact initiates identification
 - Data transfer rate of up to 16.3kbps

Mechanical interconnected locks



The CS210F mechanical interconnected locks provide panic-free, single motion egress and comply with the requirements of the National Fire Protection Association (NFPA) codes and local building codes.

To meet the demands of residents, the mechanical interconnect is available with several new features:

- Both the CS210F accept a variety of commercial and all residential levers, to provide never before available suiting options for our Schlage interconnected product line
- Available in split lever designs and finishes
- Select levers are code-compliant with return to door requirements and meet ADA requirements
- The interconnect mechanism is adjustable to 4 and 5½ door preparations
- Available with removable core and restricted keyways
- I/C core availability
- Limited lifetime mechanical warranty

Benefits

- Single motion egress meets life and safety code requirements
- Ideal for both new construction and renovation/aftermarket projects
- Easy to install, fits standard door preparations

Markets

- Apartment communities
- Assisted living communities
- Student housing
- Light commercial
- Single family condominiums and town homes

Finishes



505/605
Bright brass



609
Antique brass



619
Satin nickel



625
Bright chrome



626
Satin chrome



716/643e
Aged bronze

Specifications

ANSI/BHMA	Grade 2 certified
UL rating	UL 3-hour rating is standard
Latch	UL latch comes with 1" x 2¼" square and round corner face plans (square corner standard, round corner included in package. 1" edge bore required.
Strikes	1½" x 2¾" square corner deadbolt strikes and 2¼" x 1⅝" square corner full lip latch strikes reinforcer. Dust box not included.
Backset	Adjustable backset, fits 2⅜" or 2¾" backsets
Levers	All lever trim is non-handed and field reversible
Stile width	Minimum 4½" for 2⅜" backset, minimum 5" stile for 2¾"
Return to door	Saturn (SAT) and Neptune (NEP) lever styles are return to door code compliant
RS210F cylinder	5-pin solid brass, layered 5-pin, C keyway, keyed different (KD)
CS210F cylinder	6-pin solid brass, keyed 6-pin, C123 keyway, keyed different (KD), Keys are 6-pin, Everest S123 section.
Keys	5-pin, C section
Door range	1⅜" to 1¾" standard. 1¾" to 2 optional. Must be specified
Center to center	Fits 4" or 5½" center to center door preps

Door preparation

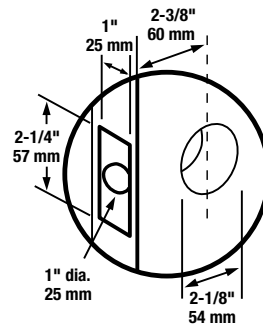



B Series mechanical deadbolts

B60 Series

Grade 1 for high-traffic residential or commercial use.

Shown: B60 single cylinder



Standard features

- Extra security with a full 1" (25mm) throw deadbolt with a concealed hardened steel roller to prevent cutting or sawing the bolt
- 5-minute, 3-step installation
- Anti-pick shield protects against hammer and crow bar attacks
- Available in single and double cylinder
- Available with full-sized interchangeable core (B60R, B62R)
- Limited lifetime mechanical and finish

Specifications

Certifications	Exceeds ANSI/BHMA certified A156.5 - 2001, Grade 1, UL Listed for 3-hour fire door (Grade 2 with FSIC)
Applications	Medium-traffic deadbolt, Grade 1 residential or commercial, exterior, new construction and retrofit applications
Deadbolt	1" x 2 1/4" (25mm x 57mm), square and round corner faceplate included, 1" (25mm) housing diameter, 1" (25mm) throw

B60R6 Series

Grade 2 for medium-traffic commercial and residential use.



Standard features

- Interchangeable core allows for quicker rekeying in multi-family applications
- ANSI/BHMA Grade 2 Product Performance
- Increased latch/bolt size offers maximum kick-in resistance
- 3 piece assembly
- Temporary construction cores may be ordered with full size interchangeable core locks, mortise cylinders and rim cylinders

Specifications

Certifications	ANSI/BHMA A156.36, 2010, Grade 2
Applications	Multi-family doors
Deadbolt	1" x 2 1/4" (25mm x 57mm), square and round corner faceplate included, 1" (25mm) housing diameter, 1" (25mm) throw

Finishes

Series	505	605 US3	606 US4	608	609 US5	612 US10	613 US10B	618 US14	619 US15	620 US15A	621 US17A	622 US19	625 US26	626 US26D	643/716 US11
B60	▪	▪	▪	▪	▪	▪	▪	▪	▪	▪	▪	▪	▪	▪	▪
B250															
B60R6	▪														▪

B250 Series

Grade 2 for medium-traffic commercial and residential use.

Shown: B250PD deadlatch



Standard features

- Ideally suited for pool, condominium gates and utility panels
- Concealed wood frame reinforcer protects from kick-in attacks
- Holdback feature keeps the deadlatch in a retracted position
- Available in single and double cylinder
- Limited lifetime mechanical and finish

Specifications

Applications	High-traffic deadlatch, Grade 2 commercial exterior, new construction and retrofit applications
Deadbolt	1 1/8" x 2 1/4" (29mm x 57mm), square corner faceplate, 1" (25mm) housing diameter, 9/16" (14mm) throw
Standard strike	1 1/8" x 2 3/4" (29mm x 70mm), square corner, box

Door preparation

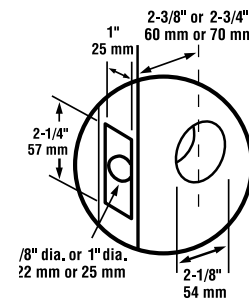

= Antimicrobial coating available on select finishes
 = High-traffic applications
 = BHMA certified
 = ANSI tested
 = Medium-traffic applications
 = Helps meet LEED certification
 = UL and/or cUL Listed

B Series mechanical deadbolts

B500 Series

Grade 2 for medium-traffic commercial and residential use.

Shown: B560P single cylinder



Standard features

- Higher security - 10 percent larger diameter deadbolt
- Tougher performance - seamless steel construction from beginning of latch to back of bolt
- Installation versatility - adjustable backset with lock-in-place helix design
- Available in single and double cylinder†
- Limited lifetime mechanical and finish

Specifications

Applications	High-traffic deadlatch, Grade 2 commercial exterior, new construction and retrofit applications
Deadlatch	1 1/8" x 2 1/4" (29mm x 57mm), square corner faceplate, 1" (25mm) housing diameter, 9/16" (14mm) throw
Standard strike	1 1/8" x 2 3/4" (29mm x 70mm), square corner, box

†Patented Primus® XP high security cylinders available.

B600, B700, B800 Series

Grade 1 for high-traffic commercial use.

Shown: B660P single cylinder



Standard features

- Solid brass or bronze rotating trim rings
- Hardened steel balls protect mounting bolts from drill attack
- Available in single and double cylinder†
- Limited lifetime mechanical and finish

Specifications

Applications	High traffic deadbolt, Grade 1 commercial exterior, new construction and retrofit applications
Deadbolt	1 1/8" x 2 1/4" (29mm x 57mm), square corner faceplate, 1" (25mm) housing diameter, 1" (25mm) throw
Standard strike	1 1/8" x 2 3/4" (29mm x 70mm), square corner, box

Finishes

Series	505	605 US3	606 US4	608	609 US5	612 US10	613 US10B	618 US14	619 US15	620 US15A	621 US17A	622 US19	625 US26	626 US26D	643/716 US11
B500	▪	▪	▪	▪	▪	▪	▪	▪	▪	▪	▪	▪	▪	▪	643
B600	▪	▪	▪	▪	▪	▪	▪	▪	▪	▪	▪	▪	▪	▪	643

Door preparation

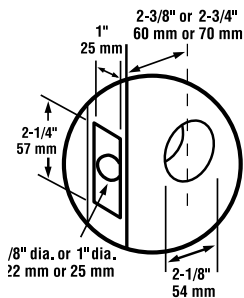

= Antimicrobial coating available on select finishes
 = High-traffic applications
 = BHMA certified
 = ANSI tested
 = Medium-traffic applications
 = Helps meet LEED certification
 = UL and/or cUL Listed

Builders hardware

Interior hardware



61 Solid door stop

- Made from aluminum or brass
- Projection: 3³/₁₆" on aluminum units
- Finishes: A3, A5, A15, A14, A26D, A716, A-W, US3, US5, US15, US26, US26D, US716



63 Flex door stop

- Made from steel
- Projection: 3"
- Finishes: F3, F5, F15, F26D, F716, US3, US5, US15, US26D, US716



221 Flush pull

- Made from wrought brass
- Inside cup diameter: 2¹/₈"; overall diameter: 2⁷/₁₆" depth: 7¹/₁₆"
- Finishes: B3, B716, B5, B14, B15, US3, US716 US5, US14, US15



262 and 265 manual flush bolt

- Made from solid brass
- Dimension: 6" x 3³/₄"
- Finishes: B3, B5, B26, B26D, B716, US3, US5, US26, US26D, US716

Exterior hardware



U700 Eye viewer

- 120° angle of view
- For doors 1³/₈" to 2¹/₁₆" thick
- UL Listed for use on fire door assemblies rated at 90 minutes
- Finishes: B4, B26D, B10B, US4, US26D, US10B

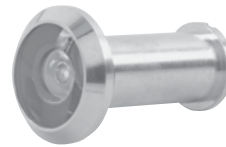

U698 Eye viewer

- 190° angle of view
- For doors 1³/₈" to 2¹/₈" thick
- U698 is UL Listed for use on fire door assemblies rated at 90 minutes
- Finishes: B3, B26, B10B, US3, US26, US10B

8400 — Residential grade kick plates

- .037 gauge



Finishes Sizes

Finishes	Sizes
PA3	6" x 30", 6" x 34", 8" x 34"
PA619	6" x 30", 6" x 34", 8" x 34"
PA28	6" x 30", 6" x 34", 8" x 34"
PA716	6" x 30", 6" x 34", 8" x 34"



601/620 Mail slots

- 11" x 2" opening
- Finishes: B3, B5, 626, B15, B26, B716, PA28, US3, US5, US26D, US15, US26, US716, US28

Builders hardware



059 Hand rail bracket

- Made from aluminum
- Base: 2 1/4" x 1 3/8"
- Finishes: A3, A5, A14, A15, A26D, A716, US3, US5, US15, US26, US26D, US716



59 Hand rail bracket

- Made from aluminum
- Brass base: 2 15/16" x 1 1/2"
- Finishes: A3, A5, A14, A15, A26D, A716, US3, US5, US15, US26, US26D, US716



436 Floor door stop

- Made from brass or aluminum
- Oval 1 3/4" x 2"
- Finishes: B3, B5, B15, B26, B26D, B716, PA3, PA5, PA14, PA15, PA92, PA716, US3, US5, US15, US26, US26D, US716



70 Hinge pin door stop

- Made from aluminum
- Removable bushings accommodate 1/4" to 5/16" diameter hinge pins
- Finishes: A3, A5, A15, A26, A26D, A716, AW, US3, US5, US15, US26, US26D, US716



07 Window lock

- Made from solid brass or aluminum
- Base: 1 5/16" x 2 9/16"
- Strike: 5/8" x 2 9/16"
- Finishes: aluminum-A3, A5, A14, A15, A92, AW, US3, US5, US15, US26, US26D, US716



026 Bar window lift

- Made from aluminum
- Base: 1 1/8" x 4"
- Finishes: B10B, B14, B15, aluminum-A3, A5, A14, A92, A5, A-716, US3, US5, US15, US26, US26D, US716



481 Door guard chain

- Made from brass or steel
- Meets design requirements of ANSI/BHMA A156.16
- Finishes: brass F26, F26D, F716, US3, US5, US15, US26, US26D, US716



990 Sliding door pull

- Made from aluminum or steel
- Doors 1 3/8" to 1 1/2"
- Size 1 3/4" x 2 1/4"
- Finishes: A3, A5, A15, A14, A92, A-716, F3, F5, F14, F92, F-716, US3, US5, US15, US26, US26D, US716



580 Ceiling hook

- Made from aluminum
- Base: 7/8" x 1 15/16, 2 1/4" projection
- Finishes: A3, A5, A14, A15, A26, A26D, A716, US3, US5, US15, US26, US26D, US716



581 Single wardrobe hook

- Made from aluminum
- Base: 1 1/4" x 1 1/8", 1 5/8" projection
- Finishes: A3, A5, A14, A15, A26, A26D, A716, US3, US5, US15, US26, US26D, US716



582 Double wardrobe hook

- Made from aluminum
- Base: 1 1/16" x 1 1/4, 1 3/32" projection
- Finishes: A3, A5, A14, A15, A26, A26D, A716, US3, US5, US15, US26, US26D, US716



991 Sliding door lock

- Made from aluminum or steel
- Doors: 1 3/8" to 1 1/2"
- Size: 1 3/4" x 2 1/4"
- Strike: 1" x 2 1/4"
- Finishes: A3, A5, A15, A14, A92, A-716, F3, F5, F14, F92, F-716, , US3, US5, US15, US26, US26D, US716



347 Ball catch

- Made from wrought brass
- Face plate: 2 1/8" x 1"
- Strike: 2 1/8" x 1 1/16"
- Finishes: B3, B5, B15, B26, B26D, B716, US3, US5, US15, US26, US26D, US716



349 Ball catch

- Made from wrought brass
- Face plate: 2 1/8" x 1"
- Strike: 2 1/8" x 1 3/8"
- Finishes: B3, B5, B15, B26, B26D, B716, US3, US5, US15, US26, US26D, US716



WS407CVX Wall guard

- Made from wrought brass
- Convex rubber bumper
- Finishes: US3, US4, US5, US10, US10B, US14, US15, US26, US26D, US28, US32D



WS407CCV Wall guard

- Made from wrought brass
- Concave rubber bumper
- Finishes: US3, US4, US5, US10, US10B, US14, US15, US26, US26D, US28, US32D



Key to finishes

IVES finish	ANSI/BHMA	US Number	Finish description	Base material
A3	666	US3	Bright brass, clear coat	Aluminum
A5		US5	Satin brass, blackened, satin relieved	Aluminum
A10	668	US10	Satin bronze, clear coat	Aluminum
A10B	703	US10B	Dark bronze, oil rubbed	Aluminum
A14	669	US14	Bright nickel, clear coat	Aluminum
A15	670	US15	Satin nickel, clear coat	Aluminum
A19	671	US19	Flat black coated	Aluminum
A26	672	US26	Bright chrome	Aluminum
A26D	702	US26D	Satin chrome	Aluminum
A716			Aged bronze	Aluminum
A92	673		Aluminum clear coat	Aluminum
A-Almond			Almond	Aluminum
A-BLK			Black	Aluminum
A-W			White	Aluminum
PA28	628	US28	Satin aluminum, clear anodized	Aluminum
B3	605	US3	Bright brass, clear coat	Brass/bronze
B4	606	US4	Satin brass, clear coat	Brass/bronze
B5	609	US5	Satin brass, blackened, satin relieved	Brass/bronze
B9	611	US9	Bright bronze, clear coat	Brass/bronze
B10	612	US10	Satin bronze, clear coat	Brass/bronze
B10B	613	US10B	Dark bronze, oil rubbed	Brass/bronze
	614	US10A	Satin bronze, relieved, clear coated	Brass/bronze
	616	US11	Satin bronze, blackened, clear coated	Brass/bronze
B14	618	US14	Bright nickel, clear coat	
B15	619	US15	Satin nickel, clear coat	Brass/bronze
B15A	620	US15A	Satin nickel, blackened, satin relieved	Brass/bronze
B26	625	US26	Bright chrome	Brass/bronze
B26D	626	US26D	Satin chrome	Brass/bronze
B716			Aged bronze	Brass/bronze
F2C	603	US2C	Zink plated	Steel
F3	632	US3	Bright brass, clear coat	Steel
F4	633	US4	Satin brass, clear coat	Steel
F5	638	US5	Satin brass, blackened, satin relieved	Steel
F10	639	US10	Satin bronze, clear coat	Steel
F10B	640	US10B	Dark bronze, oil rubbed	Steel
	641	US10A	Oxidized satin bronze, relieved, clear coated	Steel
	643	US11	Satin bronze, blackened, relieved, clear coated	Steel
F14	645	US14	Bright nickel, clear coat	Steel
F15	646	US15	Satin nickel, clear coated	Steel
F26	651	US26	Bright chrome	Steel
F26D	652	US26D	Satin chrome	Steel
	664	US27	Satin aluminum, clear anodized aluminum	Aluminum
F716			Aged bronze	Steel
F-W			White	Steel
SP4			Dull brass painted	All
SP10	691		Dull bronze painted	All
SP28	689		Aluminum painted	All
SP313	695		Dark bronze painted	All
SPBLK	622		Flat black	All
USP	600	USP	Primed for paint	All
US32	629	US32	Bright stainless steel	Stainless steel
US32D	630	US32D	Satin stainless steel	Stainless steel
US32D	654		Satin stainless steel	Stainless steel
Z605		US26	Bright chrome	Zinc
Z609		US5	Satin brass, blackened, satin relieved	Zinc
Z613		US10B	Dark bronze, oil rubbed	Zinc
Z619		US15	Bright brass, clear coated	Zinc
Z625		US26	Bright chrome	Zinc
Z716			Aged bronze	Zinc
Z-W			White	Zinc
BLK			Black	Rubber or plastic
WHT			White	Rubber or plastic
GRY			Grey	Rubber
TAN			Tan	Rubber
BRN			Brown	Rubber



Schlage® makes **distinctive** door hardware designed not just to match your personal style, but to welcome you home.

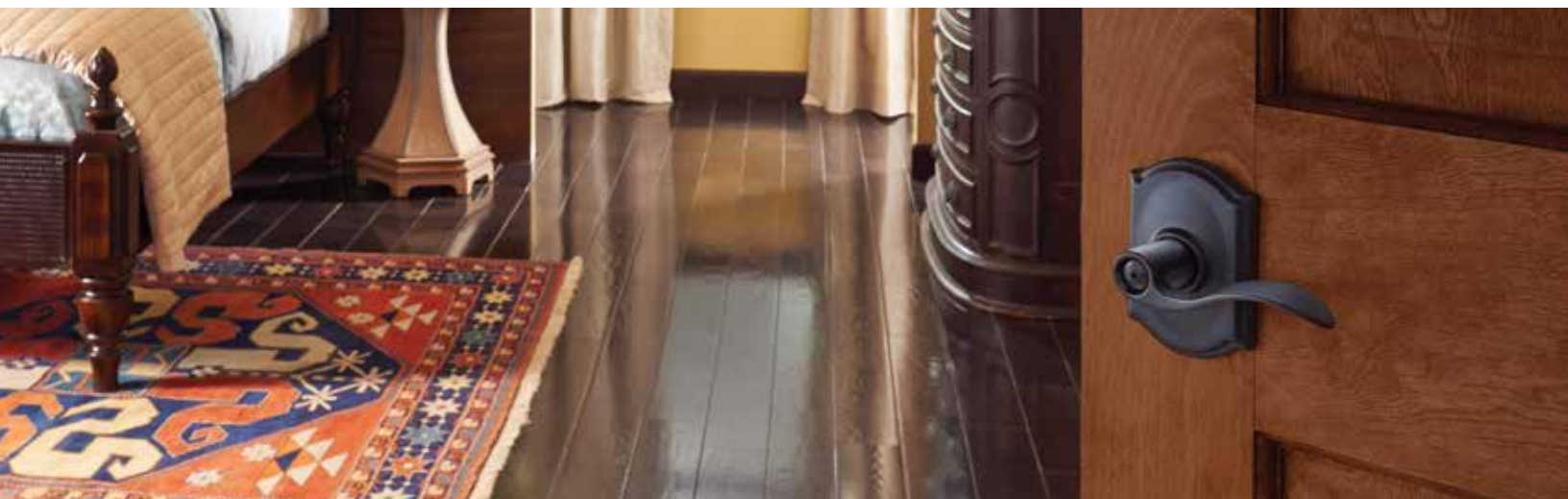

About Allegion

Allegion (NYSE: ALLE) creates peace of mind by pioneering safety and security. As a \$2 billion provider of security solutions for homes and businesses, Allegion employs more than 8,000 people and sells products in more than 120 countries across the world. Allegion comprises 27 global brands, including strategic brands CISA®, Interflex®, LCN®, Schlage® and Von Duprin®. For more, visit www.allegion.com

aptiQ ■ LCN ■ **SCHLAGE** ■ STEELCRAFT ■ VON DUPRIN