



MASONITE.

## STEEL DOOR FRAMES

FAST-FRAME® & U-INSTALL®



Open to extraordinary.™

# Choose The Right Door

FOR YOUR APPLICATION

## Masonite® Steel Door Series







W X H	FAST-FRAME.													
		FLUSH	2P SQUARE	2P CAMBER-TOP	2P CAMBER-TOP PLANK	2P W/ 23 X 65 C/O	2P HOLLISTER ST	3P CRAFTSMAN	3P ARCH-TOP	4P BLANK-TOP	4P NEW ENGLAND	6P	8P PARLIAMENT	9P CAMBER-TOP
2'0" x 6'8"	✓	■●🔥												
2'0" x 7'0"	✓	■●🔥												
2'0" x 8'0"	✓	■●🔥												
2'6" x 6'8"	✓	■●▲🔥								■●▲†		■●▲🔥†		
2'6" x 7'0"	✓	■●🔥								■●†		■●🔥†		
2'6" x 8'0"	✓	■●🔥												
2'8" x 6'8"	✓	■●▲	■●🔥	■●🔥	■●🔥		■●🔥	■●🔥	■●🔥	■●▲	■●🔥	■●▲🔥	■●🔥	■●🔥
2'8" x 7'0"	✓	■●🔥								■●		■●🔥		
2'8" x 8'0"	✓	■●🔥				■●						■●🔥		
2'10" x 6'8"	✓	■●▲🔥	■●🔥	■●🔥	■●🔥		■●🔥	■●🔥	■●🔥	■●▲	■●🔥	■●▲🔥	■●🔥	■●🔥
2'10" x 7'0"	✓	■●🔥								■●		■●🔥		
2'10" x 8'0"	✓	■●🔥				■●						■●🔥		
3'0" x 6'8"	✓	■●▲🔥	■●🔥	■●🔥	■●🔥		■●🔥	■●🔥	■●🔥	■●▲	■●🔥	■●▲🔥	■●🔥	■●🔥
3'0" x 7'0"	✓	■●🔥	■●🔥	■●🔥	■●🔥		■●🔥	■●🔥	■●🔥	■●		■●🔥		
3'0" x 8'0"	✓	■●🔥				■●						■●🔥		

■ Sta-Tru. HD availability in Wood-Edge or Steel-Edge construction ● Masonite. HD availability in Wood-Edge or Steel-Edge construction ▲ Masonite. Utility Steel availability in Wood-Edge construction 🔥 Available as Warnock-Hersey. listed fire door (Wood-Edge is 20-minute only in 6'8" and 7'0" heights, Steel-Edge is 90-minute in 6'8", 7'0" and 8'0" heights, Fire rating only available on opaque Masonite. HD or Sta-Tru. HD) †Features narrow panel layout

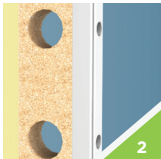
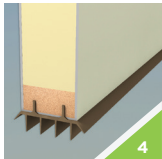
# High Definition Steel

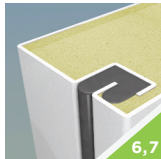
HIGH-DEFINITION PROFILES PROVIDE CURB APPEAL AND DURABILITY

Standard Features For steel-edge & wood-edge	Steel-Edge Features	Wood-Edge Features
<p><b>1. High-Definition Panel Profile</b></p> <ul style="list-style-type: none"> <li>Creates excellent shadow lines and distinct panel designs</li> </ul>	<p><b>5. Interlocking Steel-Edge</b></p> <ul style="list-style-type: none"> <li>Has six 90° steel bends in each edge to ensure stability and resist warping</li> </ul>	<p><b>9. Engineered Construction</b></p> <ul style="list-style-type: none"> <li>Finger-jointed hinge stile</li> <li>Laminated lumber lock stile</li> </ul>
<p><b>2. Internal Blocking</b></p> <ul style="list-style-type: none"> <li>Lock area is reinforced to provide solid mounting surface</li> </ul>	<p><b>6. Square-Edge Design</b></p> <ul style="list-style-type: none"> <li>Wood door appearance</li> </ul>	<p><b>10. Interlocking Design</b></p> <ul style="list-style-type: none"> <li>Grooved stiles add strength and structural rigidity</li> <li>Steel facings wrap over stiles with a "J" bend</li> <li>20-minute fire label available (opaque doors only)</li> </ul>
<p><b>3. Two Finish Options</b></p> <ul style="list-style-type: none"> <li>Masonite® HD features a baked-on primer for a more durable finish</li> <li>Sta-Tru® HD has a prefinished white surface (no initial finishing required on door panel)</li> </ul>	<p><b>7. Vinyl Extrusion</b></p> <ul style="list-style-type: none"> <li>Locks facings together and provides an insulated thermal barrier</li> <li>Hinges are flush mounted into steel reinforcements to help prevent hinge sag</li> <li>90-minute fire label available (opaque doors only)</li> </ul>	
<p><b>4. Rot-Resistant Bottom Rail</b></p> <ul style="list-style-type: none"> <li>High-performance composite material is utilized on all bottom rails</li> </ul>		

# Fast-Frame®

## ADJUSTABLE KERFED STEEL REPLACEMENT FRAMES

### The Ultimate Adjustable Kerfed Steel Door Frame

Fast-Frame's advanced design adds a new dimension of flexibility and durability to Masonite's steel entry door line. Developed and manufactured exclusively for Masonite by Timely®, Fast-Frame features a full 1" of adjustability to accommodate almost any variation in wall construction. This easy-to-install, user-friendly, kerfed steel door frame system is

applicable to a full range of residential and commercial applications – wood or steel stud construction. Timely's expertise in innovating and manufacturing steel door frame components is second to none. Fast-Frame is engineered to meet the most stringent code requirements including structural, impact and 90-minute fire ratings.

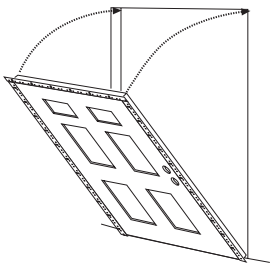

#### Outer Adjustable Closure

20-Gauge Steel  
2 Uprights - 1 Header

#### Bumper Outswing Sill

4-9/16" width

#### Tile Face Sill

4-1/4" & 6-1/4" width

#### Handicap (ADA) Sill

Double Slope 4-9/16" & 6-9/16" width

#### Standard Inswing Sill

Thermally broken - 5-5/8" width. Optional extenders for larger wall sizes.

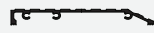

Note: Not for use on outswing applications.

Note: Not for use on outswing applications.

#### TA-1 Adjustable T-Strike

1/4" of adjustment allows for ease of field installations for proper door closure

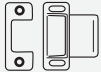

#### Closure Span Adjustment Chart

Wall Sizes	A
4-1/2" - 5-1/2" = 1-7/8"	
5-1/2" - 6-1/2" = 2-7/8"	
6-1/2" - 7-1/2" = 3-7/8"	

Wider sizes are available upon request. A

#### Weatherstripping

Schlegal foam-filled compression (QEBD500)  
90-minute fire rating

#### Primed White Galvanized Steel

Galvanized 20-gauge steel provides superior corrosion resistance, matches our Masonite HD bright white doors, and is an ideal surface for painting

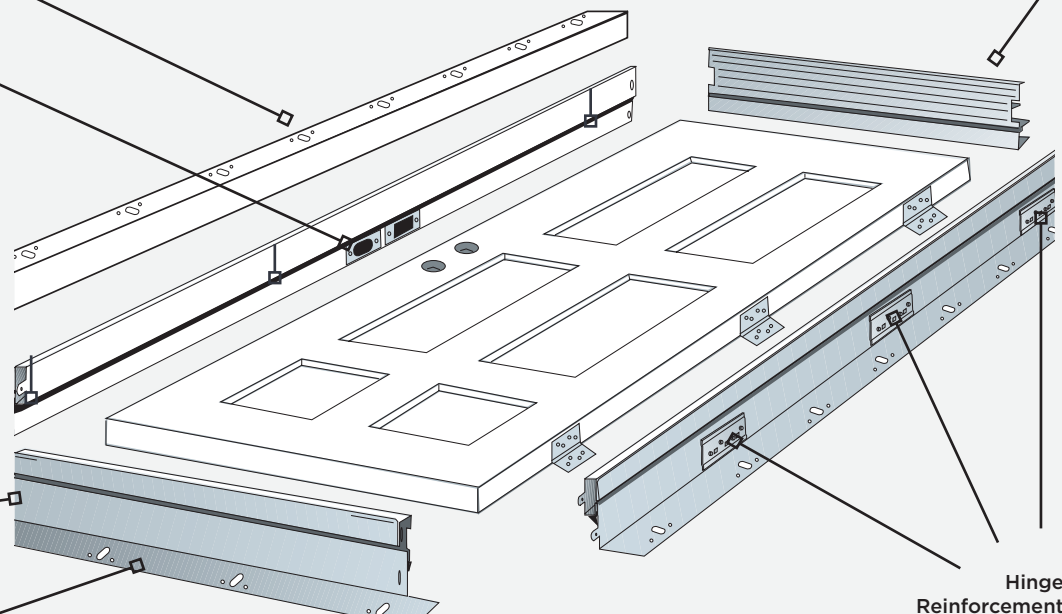

#### Hinge Reinforcement

14-gauge, unique extruded holes provide the strength of a 12-gauge hinge reinforcement



- ▶ Double door width is with a "Z" astragal. If using a 5/8" astragal then add 9/16" to the width
- ▶ All dimensions shown are for doors with standard inswing sill. Deduct 13/16" for bumper outswing or handicap compliant sill
- ▶ Add 4" to height for 7'0" height
- ▶ Add 16" to height for 8'0" height
- ▶ Premdor spec slabs add 1/4" to height

FAST-FRAME® ROUGH OPENINGS		
PREHUNG DOOR SIZES		
	Nominal Door Size	Rough Opening Size (Wood Stud)
	W x H	W x H
Single Door	2'0" x 6'8"	25-1/4" x 81-3/8"
	2'6" x 6'8"	31-1/4" x 81-3/8"
	2'8" x 6'8"	33-1/4" x 81-3/8"
	2'10" x 6'8"	35-1/4" x 81-3/8"
	3'0" x 6'8"	37-1/4" x 81-3/8"
Double Door	4'0" x 6'8"	49-1/4" x 81-3/8"
	5'0" x 6'8"	61-1/4" x 81-3/8"
	5'4" x 6'8"	65-1/4" x 81-3/8"
	5'8" x 6'8"	69-1/4" x 81-3/8"
	6'0" x 6'8"	73-1/4" x 81-3/8"

\*Z astragals only available in 6'8" and 8'0" heights †Masonite spec



# U-Install<sup>®</sup>

## STEEL REPLACEMENT FRAMES

### Quick&Easy Installation

No need to remove the old frames or hassle with complicated installation procedures. Just measure the width and height of the opening and order the frame components, door and sill. When they arrive, remove your old door, trim and threshold then assemble the new components with the replacement door and install inside your existing door frame.

#### U-INSTALL<sup>®</sup> FRAME KITS

- ▶ Pre-primed and ready to paint
- ▶ Matches Prem spec door hinge patterns
- ▶ Can be paired with either our steel or fiberglass doors
- ▶ Constructed from quality heavy duty steel

SIZE		
IF YOUR EXISTING FRAME MEASURES BETWEEN:		
Minimum Width	Maximum Width	Door Size
29-3/4"	30-1/2"	2'6"
31-3/4"	32-1/2"	2'8"
35-3/4"	36-1/2"	3'0"
Minimum Height	Maximum Height	Door Size
80"	80-1/2"	6'8"
84"	84-1/2"	7'0"

#### REPLACEMENT SIZE DOORS

- ▶ Undersized to fit directly into your existing frame
- ▶ Can be fitted with your choice of our glass
- ▶ Wide variety of styles and configurations available

REPLACEMENT DOORS			
DOOR SIZES AVAILABLE			
Door Style	Flush	4 Panel Blank Top	6 Panel
2'6" x 6'8"	•	•	•
2'8" x 6'8"	•	•	•
3'0" x 6'8"	•	•	•



Masonite<sup>®</sup>, "Open to Extraordinary<sup>™</sup>" Fast-Frame<sup>®</sup> and U-Install<sup>®</sup> are trademarks of Masonite International Corporation. Warnock Hersey is a registered trademark of Intertek Testing Services. Timely is a registered trademark of S.D.S. Industries, Inc. which has been licensed to Frame-Up, LLC. Please check with your Masonite dealer or distributor for current warranty terms and conditions. Our continuing program of product improvement makes specification, design and product detail subject to change without notice. 6/13 © 2017 by Masonite International Corporation. **For more information contact: 1-800-663-DOOR (1-800-663-3667) 9a - 5p Mon - Fri EST**